

Low Voltage

Compact NSX100 to 630

Circuit breakers and switch-disconnectors

Substitution guide
2009



Substitution guide

Performance levels and trip units	2
Compact NS100/160/250	2
Compact NSX100/160/250	3
Compact NS400/630	4
Compact NSX400/630	5

Dimensions and mounting	6
--------------------------------	----------

Electrical auxiliaries	9
-------------------------------	----------

Trip unit selection	10
Compact NSX100 to 250	10
Substitution for magnetic/thermal-magnetic trip units	10
Substitution for electronic trip units	11
Compact NSX400/630	12
Substitution for magnetic and electronic trip units	12
Substitution for electronic trip units	13

Substitution table	14
Compatibility of components Compact NS to NSX and Compact NSX to NS	14



This guide is intended to:

- provide the information you need to replace a device from the Compact NS range by a device from the Compact NSX range
- help you choose a Compact NSX device by referring to the previous range.

For further information see:

- the Compact NSX catalogue LVPED208001EN
- the Compact NSX installation leaflets
- the Compact NSX using guide LV434101

Performance levels and trip units

Compact NS100/160/250

One frame size

NS100/160/250

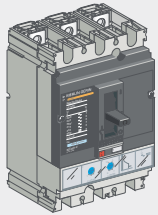

NS400/630

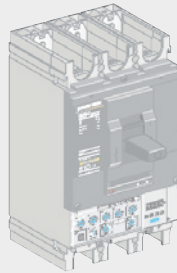

4 perf. levels: N, SX, H, L (at 415 V, for networks ≤ 690 V)

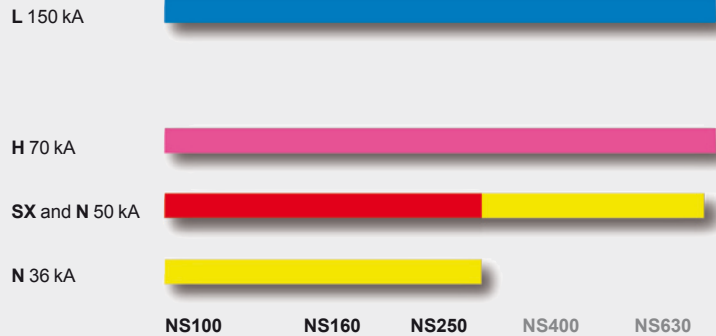

Trip units for Compact NS100/160/250 ⁽¹⁾

Magnetic MA or thermal-magnetic TM

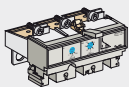

MA

- In: 2.5 to 100 A
- Im: adjustable magnetic pick-up

TM-D
(Distribution)

- In: 16 to 250 A
- Im: fixed or adjustable magnetic pick-up, depending on rating
- Ir: adjustable thermal pick-up from 0.8 ... 1 In

TM-G
(Generator)

- In: 16 to 63 A
- Im: low fixed pick-up
- Ir: adjustable thermal pick-up from 0.8 ... 1 In

Equivalent range

STR electronic

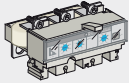

STR22SE
(Distribution)

- In: 40 to 250 A
- Protection: $LS_{OI}^{(2)}$
- N protection ⁽³⁾ on 4P devices: unprotected, N/2, N

STR22SE OSN ⁽³⁾
(Distribution)

- In: 160 - 250 A
- Protection: $LS_{OI}^{(2)}$
- N protection ⁽³⁾ on 4P devices: unprotected and 0.8 Ir or OSN

STR22GE
(Generator)

- In: 40 to 250 A
- Protection: $LS_{OI}^{(2)}$

STR22ME
(Motors)

- In: 20 to 220 A
- Protection: $LS_{OI}^{(2)}$
- Trip class: 10
- **lumb**: fixed phase unbalance pick-up (40 %) with fixed time delay

New enhanced Micrologic 2 range

(1) Not compatible with Compact NSX.

(2) **Type of protection**

L = Long time with adjustable Ir pick-up

So = Short time Isd pick-up with fixed time delay

S = Short time Isd pick-up with adjustable time delay

I = Fixed instantaneous Ii pick-up

G = Ground fault

(3) **N protection**

N = Neutral protection at phase current setting: Ir

N/2 = Reduced neutral protection: 0.5 Ir

OSN = Oversized Neutral: 1.6 Ir
Oversized neutral protection for networks with harmonics rank 3 and multiple of 3

(4) Not compatible with Compact NS.

*New Micrologic 5, 6 range with built-in metering functions:
A (Ammeter)
E (A+Energy)*

Compact NS120/160/250NA switch-disconnectors

Compact NSX100/160/250

One identical frame size

NSX100/160/250

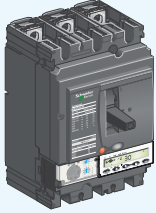

NSX400/630



6 perf. levels: B, F, N, H, S, L (at 415 V, networks ≤ 690 V)

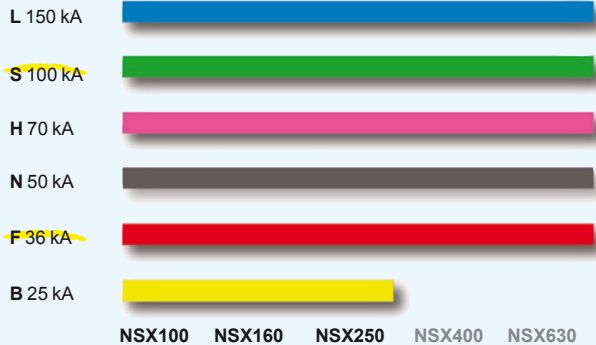

One letter and one colour defines:
 ■ the performance level
 ■ the field of application

Trip units for Compact NSX100/160/250⁽⁴⁾

Magnetic MA or thermal-magnetic TM

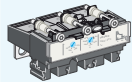

MA

- In: 2.5 to 100 A
- Im: adjustable magnetic pick-up

TM-D

(Distribution)

- In: 16 to 250 A
- Im: fixed magnetic pick-up
- Ir: adjustable thermal pick-up from 0.7 ...1 In

TM-G

(Generator)

- In: 16 to 63 A
- Im: low fixed pick-up
- Ir: adjustable thermal pick-up from 0.7 ...1 In

TM-D and **TM-G** trip units can be used on 400 Hz and 16Hz 2/3 networks with pick-up corrections.

Micrologic 2 electronic

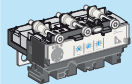

Micrologic 2.2
(Distribution)

- In: 40 to 250 A
- Protection: **LS_oI**⁽²⁾
- Adjustable **N**⁽³⁾ protection on 4P devices: unprotected, N/2, N

OSN⁽³⁾: see

Micrologic 5.2

Micrologic 2.2-G
(Generator)

- In: 40 to 220 A
- Protection: **LS_oI**⁽²⁾

Micrologic 2.2-M
(Motors)

- In: 25 to 220 A
- Protection: **LS_oI**⁽²⁾
- Adjustable trip class: 5, 10, 20
- **I_{umb}**: fixed phase unbalance pick-up (30 %) with fixed time delay

Micrologic 2.2-AB
(Service connection)

- In: 100 to 240 A
- Protection: **LS_oI**⁽²⁾
- Suitable for connection to LV public distribution network

Electronic Micrologic 5/6 A or E

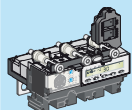

Micrologic 5.2
A or E

(Distribution with measurements)

- In: 40 to 250 A
- Protection: **LSI**⁽²⁾ with fine adjustment and display
- Adjustable **N**⁽³⁾ protection on 4P devices via keypad: unprotected, N/2, N, OSN

Micrologic 6.2
A or E

(same as 5.2 + ground fault prot.)

- In: 40 to 250 A
- Protection: **LSIG**⁽²⁾ with fine adjustment and display
- **G**: Adjustable ground fault pick-up **I_g** and adjustable delay with I²t On/Off
- Adjust. **N**⁽³⁾ protection on 4P devices via keypad: unprotected, N/2, N, OSN

Micrologic 6.2 E-M

(Motors + ground fault with E metering)

- In: 25 to 220 A
- Protection: **LSIG**⁽²⁾ with fine adjustment and display
- Adjustable trip class: 5, 10, 20, 30
- Adjustable phase unbalance **I_{umb}**, locked rotor **I_{jam}**, underload **I_{und}** and long start **I_{long}** pick-ups and time delays

Micrologic 5.2-AZ
16 Hz 2/3 networks

- In: 100 to 250 A
- Protection: **LSI**⁽²⁾ with fine adjustment and display
- 3P only. Special sampling frequency and measurements for 16 Hz 2/3 networks

Micrologic devices can be used at 400 Hz with a limitation on the maximum setting.

Compact NSX100/160/250NA switch-disconnectors

Performance levels and trip units

Compact NS400/630

One frame size

NS100/160/250

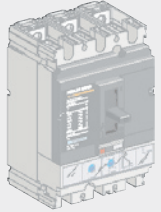

NS400/630

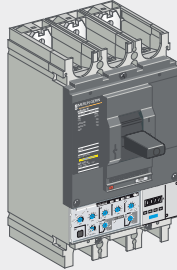

3 perf. levels: N, H, L (at 415 V, for networks ≤ 690 V)

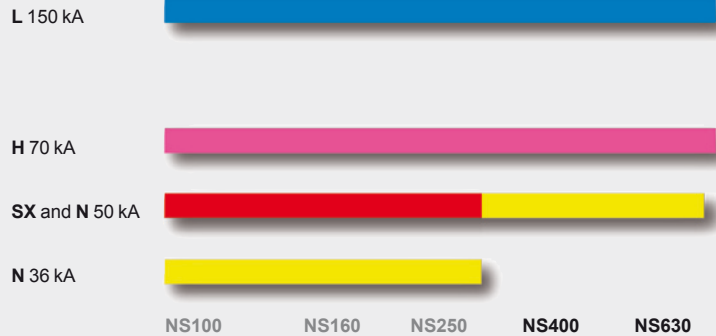

Trip units for Compact NS400/630⁽¹⁾

MA magnetic

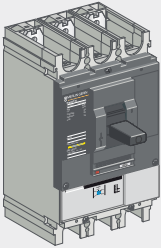

- In: 320 and 500 A
- Im: adjustable magnetic pick-up

New electronic equivalent

STR electronic



STR23SE
(U ≤ 525 V)

- In: 150 to 630 A
- Protection: **LS₀I**⁽²⁾
- N protection⁽³⁾ on 4P devices: unprotected, Nr, N

STR23SV
(U > 525 V)
(Distribution)

STR23SE OSN⁽³⁾
(Distribution)

- In: 400 to 630 A
- Protection: **LS₀I**⁽²⁾
- N protection⁽³⁾ on 4P devices: unprotected and 0.8 Ir or OSN

STR43ME
(Motors)

- In: 120 to 500 A
- Protection: **LS₀I**⁽²⁾
- Trip class: 10 A, 10, 20
- Id: fixed phase unbalance pick-up (40 %) with fixed time delay
- Fixed instantaneous Ii

STR53UE
(U ≤ 525 V)

- In: 150 to 630 A
- Protection: **LSI**
- N protection⁽³⁾ on 4P devices: unprotected, N/2, N

STR23SV
(U > 525 V)
(Distribution)

New enhanced Micrologic 2 range

*New Micrologic 5, 6 range with built-in metering functions:
A (Ammeter)
E (A+Energy)*

(1) Not compatible with Compact NSX.

(2) Type of protection

- L = Long time with adjustable Ir pick-up
- So = Short time I_{sd} pick-up with fixed time delay
- S = Short time I_{sd} pick-up with adjustable time delay
- I = Fixed instantaneous Ii pick-up
- G = Ground fault

(3) N protection

- N = Neutral protection at phase current setting: Ir
- N/2 = Reduced neutral protection: 0.5 Ir
- OSN = Oversized Neutral: 1.6 Ir
- Oversized neutral protection for networks with harmonics rank 3 and multiple of 3

(4) Not compatible with Compact NS.

Compact NS400/630NA switch-disconnectors

Compact NSX400/630

One identical frame size

NSX100/160/250

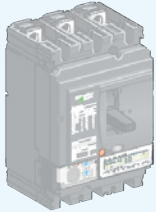

NSX400/630

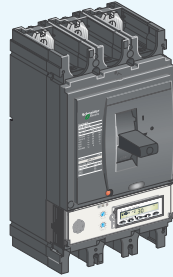

5 perf. levels: F, N, H, S, L (at 415 V, for networks ≤ 690 V)

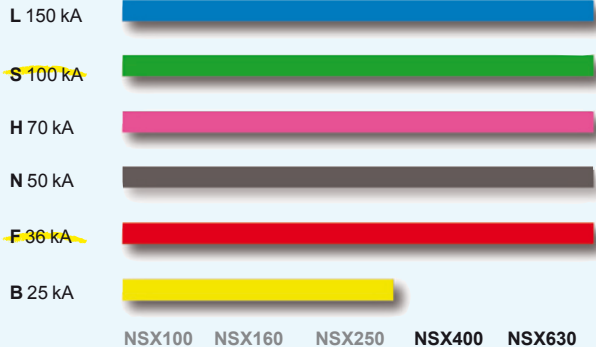

One letter and one colour defines:
 ■ the performance level
 ■ the field of application

Trip units for Compact NSX400/630⁽⁴⁾

Micrologic electronic

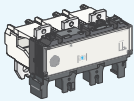

Micrologic 1.3-M

- In: 320 - 500 A
- Im: instantaneous magnetic pick-up directly adjustable in Amps

Micrologic 2 electronic

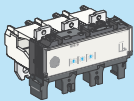

Micrologic 2.3
(Distribution)

- In: 250 to 630 A
- Protection: **LS_oI**⁽²⁾
- Adjustable **N**⁽³⁾ protection on 4P devices via keypad: unprotected, N/2, N

OSN⁽³⁾: see
Micrologic 5.3

Micrologic 2.3-M
(Motors)

- In: 320 to 500 A
- Protection: **LS_oI**⁽³⁾
- Trip class: 5, 10, 20
- Id: fixed phase unbalance pick-up (30 %)

Micrologic
2.3-AB (Service
connection)

- In: 400 A
- Protection: **LS_oI**⁽²⁾
- Suitable for connection to LV public distribution network

Electronic Micrologic 5 / 6 A or E

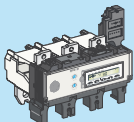

Micrologic 5.3
A or E
(Distribution with
measurements)

- In: 400 to 630 A
- Protection: **LSI**⁽²⁾
- Adjustable **N**⁽³⁾ protection on 4P devices via keypad: unprotected, N/2, N, OSN

Micrologic devices can be used at 400 Hz with a limitation on the maximum setting.

Micrologic 6.3
A or E
(same as 5.3 +
ground fault prot.)

- In: 400 to 630 A
- Protection: **LSIG**
- G: Adjustable ground fault pick-up and adjustable time delay with I²t On/Off
- Adjust. **N**⁽³⁾ protection on 4P devices via keypad: unprotected, N/2, N, OSN

Micrologic
6.3 E-M
(Motors + ground
fault with E metering)

- In: 320 to 500
- Protection: **LSIG**⁽²⁾ with fine adjustment and display
- Adjustable trip class: 5, 10, 20, 30
- Adjustable phase unbalance **I_{umb}**, locked rotor **I_{jam}**, underload **I_{und}** and long start **I_{long}** pick-ups and time delays

Micrologic 5.3-AZ
16 Hz 2/3 networks

- In: 400 to 630 A
- Protection: **LSI**⁽²⁾ with fine adjustment and display
- 3P only. Special sampling frequency and measurements for 16 Hz 2/3 networks

Compact NSX400/630NA switch-disconnectors

Dimensions and mounting

Fixed version

Compact NS Compact NSX

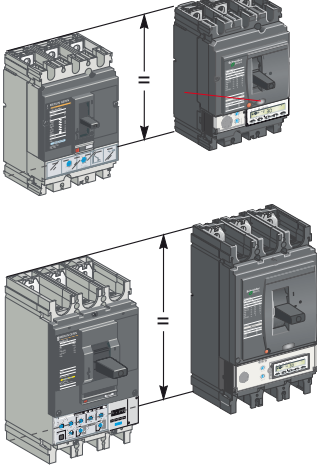

Two identical frame sizes using the same mounting system as the Compact NS range

- Replacement/extension in an existing switchboard**
- Compact NS replaced by a Compact NSX identical in size.
 - Same connection points.
 - Same fixing points.

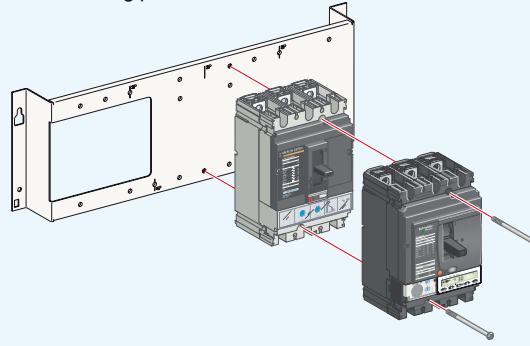

Plug-in version

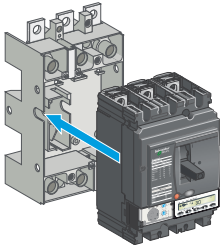

NS base NSX100/250

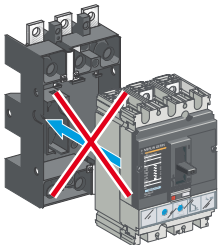

NSX base NS

Ascending compatibility from Compact NS to Compact NSX

Compact NS base can be used for Compact NSX, but reverse not possible

- The plug-in base:
 - of an Compact NS may be used for an Compact NSX
 - but that of an Compact NSX may not be used for an Compact NS.

⚠ For NSX400/630 safety trip interlock LV432520.

⚠ Check the wiring and the compatibility of the auxiliary wires.

Withdrawable version

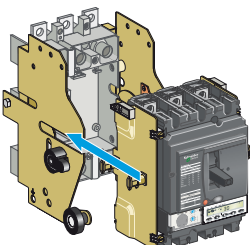

NS chassis NSX

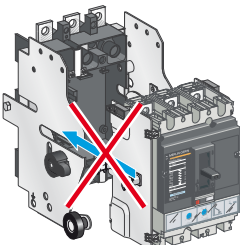

Ascending compatibility from Compact NS to Compact NSX

Compact NS chassis can be used for Compact NSX, but reverse not possible

- The chassis:
 - of an Compact NS may be used for an Compact NSX
 - but that of an Compact NSX may not be used for an Compact NS.

⚠ Check the wiring and the compatibility of the auxiliary wires.

Door cutouts for all control types

For Compact NS, there are two types of door cutouts:

- small cutout for toggles
- large cutout for rotary handles, extended rotary handles and motor mechanisms.

Access to the trip unit is not possible via a cutout.

For Compact NSX, there is only one cutout for all control types.

It is identical in size to the large cutout for Compact NS.

There is also an option for a larger cutout that provides access to the trip unit.

Toggle control

Compact NS

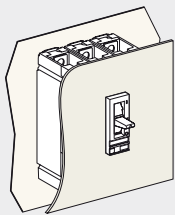

Compact NSX

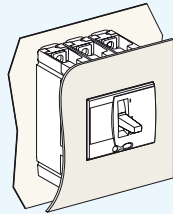

With access to the trip unit

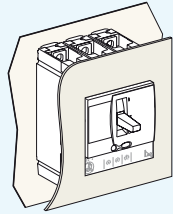

Retrofit front cover

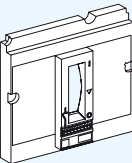

NSX100 to 250

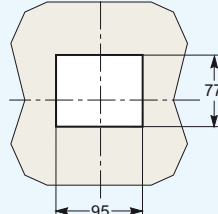

NSX400/630

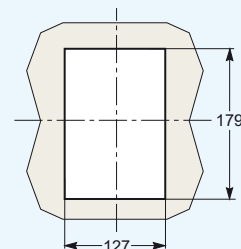
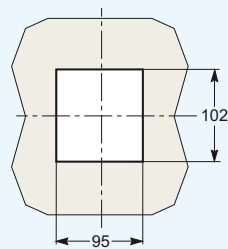
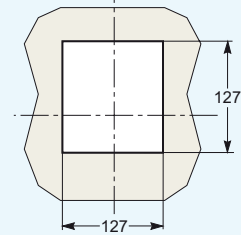

Retrofitting using an NS retrofit front cover

- The Compact NS retrofit front cover replaces the original Compact NSX front cover.

Rotary handle

The cutouts are identical **but the rotary handles are not totally interchangeable.**

- A Compact NS rotary handle may be used only on a Compact NS.
- A Compact NSX rotary handle may be used on a Compact NSX or NS.

Compact NS

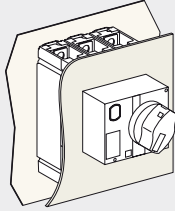

Compact NSX

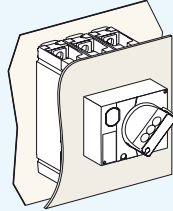

NSX100 to 250

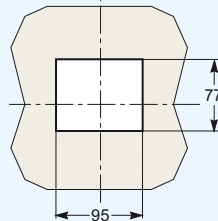

NSX400/630

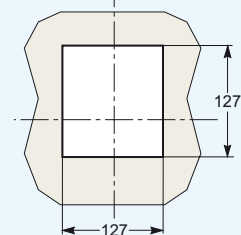

Extended rotary handle

Compact NS

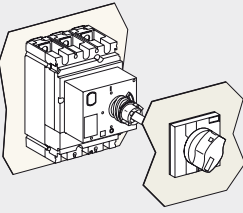

Compact NSX

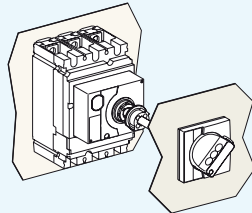

The handles are secured to the door in the same way.

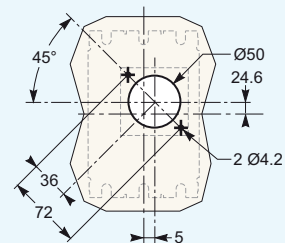
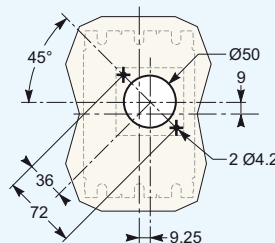

Dimensions and mounting

Motor mechanism

The cutouts are identical **but the motor mechanisms are not totally interchangeable.**

- A Compact NS motor mechanism may be used only on a Compact NS.
- A Compact NSX motor mechanism may be used on a Compact NSX or NS.

Compact NS

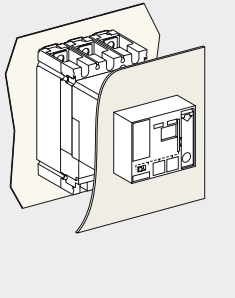

Compact NSX

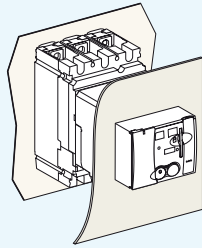

NSX100 to 250

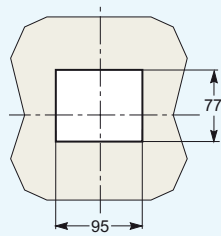

NSX400/630

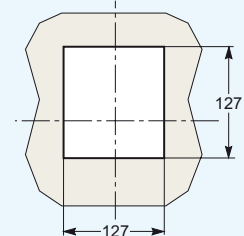

Terminal shields

Compact NS

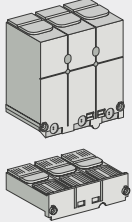

Compact NSX

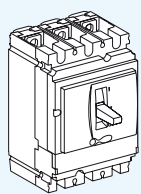
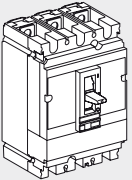
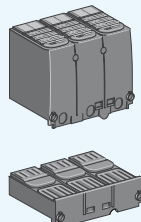

Terminal shields are fully compatible between the Compact NS and Compact NSX ranges.

Electrical auxiliaries

MN - MX - Auxiliary contacts

Compact NS

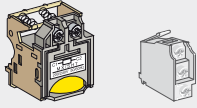

Compact NSX

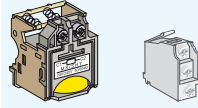

Total compatibility between the Compact NS and Compact NSX ranges.

SDx, SDTAM, BSCM, NSX cord, etc.

Compact NSX

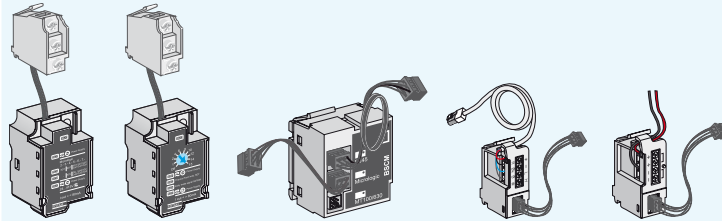

Indication and communication accessories dedicated to Compact NSX

Trip unit selection

Compact NSX100 to 250

Substitution for magnetic/thermal-magnetic trip units

Compact NS100 to 250 N/H/L Compact NSX100 to 250 B/F/N/H/S/L

Magnetic only

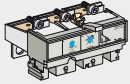

MA				
Rating (A)	Type	NS100	NS160	NS250
2.5	MA2.5	■	-	-
6.3	MA6.3	■	-	-
12.5	MA12.5	■	-	-
25	MA25	■	■	-
50	MA50	■	■	-
100	MA100	■	■	■
150	MA150	-	■	■
220	MA220	-	-	■
Thermal I _r	None			
Magnetic I _m (instantaneous)	Adjustable	6...14 I _n (< 100 A) 9...14 I _n (≥ 100 A)		

Magnetic only

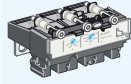

MA			
Type	NSX100	NSX160	NSX250
MA2.5	■	-	-
MA6.3	■	-	-
MA12.5	■	-	-
MA25	■	-	-
MA50	■	-	-
MA100	■	■	-
MA150	-	■	■
MA220	-	-	■
Thermal I _r	None		
Magnetic I _m (instantaneous)	Adjustable	6...14 I _n (< 100 A) 9...14 I _n (≥ 100 A) adjustable in amps.	

Thermal magnetic

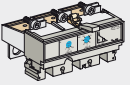

TM-D (Distribution)				
Rating (A)	Type	NS100	NS160	NS250
16	TM16D	■	■	■
25	TM25D	■	■	■
32	TM32D	■	■	■
40	TM40D	■	■	■
50	TM50D	■	■	■
63	TM63D	■	■	■
80	TM80D	■	■	■
100	TM100D	■	■	■
125	TM125D	-	■	■
160	TM160D	-	■	■
200	TM200D	-	-	■
250	TM250D	-	-	■
Thermal I _r	Adjustable	0.8...1 I _n		
Magnetic I _m (instantaneous)	Fixed	8 to 12.5 I _n if I _n ≤ 160 A		
	Adjustable	5...10 I _n for 200 and 250 A		

Thermal magnetic

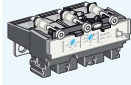

Range 0.7...1 I_n and adjustable in amps

TM-D			
Type	NSX100	NSX160	NSX250
TM16D	■	-	-
TM25D	■	-	-
TM32D	■	-	-
TM40D	■	-	-
TM50D	■	-	-
TM63D	■	-	-
TM80D	■	■	-
TM100D	■	■	-
TM125D	-	■	■
TM160D	-	■	■
M200D	-	-	■
M250D	-	-	■
Adjust.	0.7...1 I _n		
Fixed	8 to 12.5 I _n if I _n ≤ 160 A		
Adjust.	5...10 I _n for 200 and 250 A adjustable in amps.		

Alternative with electronic trip unit

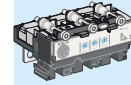

Wider and more precise setting ranges (0.4...1 I_n). A single trip unit offers the setting possibilities of several TM-D or TM-G trip units.

or Micrologic 2.2

Micrologic 2.2				
Rating (A)	Type	NSX100	NSX160	NSX250
40	2.2 40	■	■	■
	2.2 40	■	■	■
	2.2 40	■	■	■
100	2.2 100	■	■	■
	2.2 100	■	■	■
	2.2 100	■	■	■
160	2.2 160	-	■	■
	2.2 160	-	■	■
250	2.2 250	-	-	■
	2.2 250	-	-	■
Long time I _r	Adjustable	0.4...1 I _n + fine adjustment 0.9...1 via dial		
Short-time I _{sd} , fixed delay	Adjustable	from 1.5...10 x I _n Non-tripping time ≤ 20 ms		
Instant. I _{ii}	Fixed	≥ 12 I _n		
4P N protection	Off	- 0.5 or 1 I _r		

TM-G (Generator)

TM-G (Generator)				
Rating (A)	Type	NS100	NS160	NS250
16	TM16G	■	■	■
25	TM25G	■	■	■
40	TM40G	■	■	■
63	TM63G	■	■	■
Thermal I _r	Adjustable	0.8...1 I _n		
Magnetic I _m (instantaneous)	Fixed	2...4 I _n depending on I _n		

TM-G

TM-G			
Type	NSX100	NSX160	NSX250
TM16G	■	-	-
TM25G	■	■	-
TM40G	■	■	■
TM63G	■	■	■
Adjust.	0.7...1 I _n		
Fixed	2...4 I _n depending on I _n		

or Micrologic 2.2 G (Generator)

Micrologic 2.2 G (Generator)				
Rating (A)	Type	NSX100	NSX160	NSX250
40	2.2 40G	■	■	■
	2.2 40G	■	■	■
	2.2 40G	■	■	■
100	2.2 100G	■	■	■
	2.2 100G	■	■	■
Long time I _r	Adjustable	0.4...1 I _n + fine adjustment 0.9...1 via dial		
Short-time I _{sd} , fixed delay	Adjustable	from 1.5...9 I _n Non-tripping time ≤ 140 ms		
Instant. I _{ii}	Fixed	≥ 12 I _n		

Compact NSX100 to 250 Substitution for electronic trip units

Compact NS100 to 250 N/H/L Compact NSX100 to 250B/F/N/H/S/L

Electronic

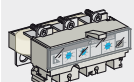

STR22SE (Distribution)

Rating (A)	Type	NS100	NS160	NS250
40	22SE40	■	■	■
80	22SE80	-	■	■
100	22SE100	■	■	■
160	22SE160	-	■	■
250	22SE250	-	-	■
Long time I _r	Adjustable 0.4...1 I _n			
Short time I _{sd} , fixed delay	Adjustable 2...10 I _n Non-tripping time ≤ 40 ms			
Instant. I _i	Fixed ≥ 11 I _n			
4P N protection	Off - 0.5 or 1 I _r			

STR22SE OSN (Distribution)

Rating (A)	Type	NS100	NS160	NS250
100	22OSN160	-	■	■
160	22OSN250	-	-	■
Long time I _r	Adjustable 0.25...0.63 I _n			
Short time I _{sd} , fixed delay	Adjustable 2...10 I _n			
Instant. I _i	Fixed ≥ 7 I _n			
4P N protection	Off - 0.8 or 1.6 I _r			

STR22GE (Generator)

Rating (A)	Type	NS100	NS160	NS250
40	22GE40	■	■	■
100	22GE100	■	■	■
160	22GE160	-	■	■
250	22GE250	-	-	■
Long time I _r	Adjustable 0.4...1 I _n			
Short time I _{sd} , fixed delay	Adjustable 2...10 I _n Non-tripping time ≤ 40 ms			
Instant. I _i	Fixed ≥ 11 I _n			

STR22ME (Motor)

Rating (A)	Type	NS100	NS160	NS250
20 to 100	22ME100	■	■	■
150	22ME150	-	■	■
220	22ME220	-	-	■
Long time I _r	Adjustable from 0.6...1 I _n			
Class	10			
Short time I _{sd} , fixed delay	Fixed 13 I _r Non-tripping time ≤ 10 ms			
Instant. I _i	Fixed 15 I _n			

Alternative with measurements

A: Ammeter

E: Energy

Management of installation and installed devices, built-in display, fine adjustment, operating information

Electronic

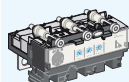

Micrologic 2.2

Rating (A)	Type	NSX100	NSX160	NSX250
40	2.2 40	■	■	■
100	2.2 100	■	■	■
	2.2 100	■	■	■
160	2.2 160	-	■	■
250	2.2 250	-	-	■
Long time I _r	Adjustable 0.4...1 I _n + fine adjustment 0.9...1 via dial			
I _{sd} , fixed delay	Adjustable 1.5...10 I _n Non-tripping time ≤ 20 ms			
Instant. I _i	Fixed ≥ 11 I _n			
4P N protect.	Off - 0.5 or 1 I _r			

or Micrologic 5.2 A or E

Type	NSX100	NSX160	NSX250
5.2 40	■	■	■
5.2 100	■	■	■
5.2 100	■	■	■
5.2 160	-	■	■
5.2 250	-	-	■
Long time I _r	Adjustable 0.4...1 I _n + fine adjustment 0.9...1 via dial		
I _{sd} , fixed delay	Adjustable 1.5...10 I _n Adj. delay 0.1-0.2-0.3-0.4 s + I ² t On/Off		
Instant. I _i	Adj. 1.5...12 I _n or 15 I _n depending on I _n		
4P N protection	Off - 0.5 or 1 or 1.6 I _n (OSN)		

Micrologic 6.2 A or E

Same as 5.2 + adjust. ground fault prot.
I_g 0.2...1 I_n, delay 0...0.4 s + I²t On/off

Micrologic 5.2 A or E

with OSN protection

Micrologic 2.2-G (Generator)

Rating (A)	Type	NSX100	NSX160	NSX250
40	2.2-G40	■	■	■
100	2.2-G100	■	■	■
160	2.2-G160	-	■	■
250	2.2-G250	-	-	■
Long time I _r	Adjustable 0.4...1 I _n + fine adjustment 0.9...1 via dial			
I _{sd} fixed delay	Adjustable 1.5...9 I _n Non-tripping time ≤ 140 ms			
Instant.	Fixed ≥ 12 I _n			

or Micrologic 5.2 A or E

Thanks to its wide setting ranges

Micrologic 2.2-M (Motor)

Rating (A)	Type	NSX100	NSX160	NSX250
25	2.2-M25	■	■	■
50	2.2-M50	■	■	■
-	-	-	-	-
100	2.2-M100	■	■	■
150	2.2-M150	-	■	■
220	2.2-M220	-	-	■
Long time I _r	Adjustable 0.5...1 I _n			
Class	5, 10, 20			
I _{sd} , fixed delay	Adjustable 5...13 I _n Non-tripping time ≤ 20 ms			
Instant. I _i	Fixed 15 I _n			
Ph unbalance Id	Fixed 30 %, fixed delay			

or Micrologic 6.2 E-M (Motor)

Type	NSX100	NSX160	NSX250
6.2 E-M25	■	■	■
6.2 E-M50	■	■	■
6.2 E-M80	■	■	■
-	-	-	-
6.2 E-M150	-	■	■
6.2 E-M220	-	-	■
I _r adj.	0.5...1 I _n + fine adjust via keypad		
Trip class	5, 10, 20, 30		
I _{sd}	adjustable 5...13 I _n with fixed delay, non-tripping time ≤ 20 ms		
I _i	fixed 13 I _n		
Ground fault I _g	adjustable 0.2...1 I _r , adjustable delay 0...0.4 s + I ² t On/off		
I _d	adjustable 10...40 %, delay 0.7...10 s		
Locked rotor I _{jam}	adjust Off / 1...8 I _r , adjustable delay 1...30 s		
Under-load I _{und}	adjust. Off / 0.3...0.9 I _r , adjustable delay 1...200 s		
Long start I _{long}	adjustable Off / 1...8 I _r , adjustable delay 1...200 s		

Trip unit selection

Compact NSX400/630

Substitution for magnetic and electronic trip units

Compact NS400/630 N/H/L Compact NSX400/630 B/F/N/H/S/L

With MA magnetic trip unit

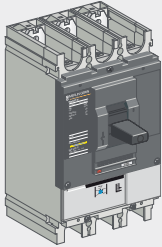

MA (magnetic only)

Rating (A)	Type	NS400	NS630
320	MA320	■	-
500	MA500	-	■
Thermal I _r	None		
Magnetic I _m (instantaneous)	Adjustable	6...14 I _n (400 A) 6...13 I _n (630 A)	

With Micrologic 1.3

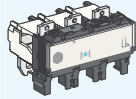

Micrologic 1.3-M

Rating (A)	Type	NSX400	NSX630
320	1.3-M320	■	■
500	1.3-M500	-	■
Long time I _r	None		
Short-time I _{sd} , fixed delay	Adjustable 5...13 I _n		
Instantaneous I _i	Non-tripping time ≤ 20 ms Fixed ≥ 13 I _n		

Compact NSX400/630

Substitution for electronic trip units

Compact NS400/630 N/H/L Compact NSX400/630 B/F/N/H/S/L

With STR23, STR43 or STR53 electronic trip unit



STR23SE (U ≤ 525 V) or 23SV (U > 525 V) (Distribution)

Rating (A)	Type	NS400	NS630
150	23SE/SV150	■	-
250	23SE/SV250	■	-
400	23SE/SV400	■	-
630	23SE/SV630	-	■
Long time I _r	Adjustable 0.4...1 I _n		
Short-time I _{sd} , fixed delay	Adjustable 2...10 I _n Non-tripping time ≤ 40 ms		
Instant. I _i	Fixed 11 I _n		
4P N protection	Off - 0.5 or 1 I _r		

STR23SE OSN (Distribution)

Rating (A)	Type	NS400	NS630
400	23OSN400	■	-
630	23OSN630	-	■
Long time I _r	Adjustable 0.25...0.63 I _n		
Short-time I _{sd} , fixed delay	Adjustable 2...10 I _n		
Instant. I _i	Fixed 7 I _n		
4P N protection	Off - 0.8 or 1.6 I _r		

STR43ME (Motor)

Rating (A)	Type	NS400	NS630
120	43ME120	■	-
200	43ME200	■	-
320	43ME320	■	-
500	43ME500	-	■
Long time I _r	Adjustable 0.4...0.8 I _n		
Class	10 A, 10, 20		
Short-time I _{sd} , fixed delay	Adjustable 6...13 I _n Non-tripping time ≤ 10 ms		
Instant. I _i	Fixed 13 I _n		
Unbalance I _d	40 %, fixed delay		

STR53SE (U ≤ 525 V) ou 53SV (U > 525 V) (Distribution)

Rating (A)	Type	NS400	NS630
150	53SE/SV150	■	-
250	53SE/SV250	■	-
400	53SE/SV400	■	-
630	53SE/SV630	-	■
Long time I _r	Adjustable 0.4...1 I _n		
Short time I _{sd} fixed delay	Adjustable 1.5...10 I _n Non-tripping time adjustable		
Instant. I _i	Adjustable 1.5...11 I _n		
4P N protection	Off - 0.5 or 1 I _r		

With Micrologic 2.3 trip unit

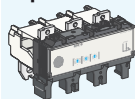

Micrologic 2.3

Rating (A)	Type	NSX400	NSX630
250	2.3 250	■	■
	2.3 250	■	■
400	2.3 400	■	■
630	2.3 630	-	■
Long time I _r	Adjustable 0.4...1 I _n + fine adjust 0.9...1 via dial		
Short-time I _{sd} , fixed delay	Adjustable 1.5...10 I _n Non-tripping time ≤ 20 ms		
Instant. I _i	Fixed ≥ 11 I _n		
4P N protection	Off - 0.5 or 1 I _r		

Micrologic 2.3-M (Motor)

Rating (A)	Type	NSX400	NSX630
	2.3-M320	■	■
	2.3-M320	■	■
320	2.3-M320	■	■
500	2.3-M630	-	■
Long time I _r	Adjustable 0.5...1 I _n		
Class	5, 10, 20		
Short-time I _{sd} , fixed delay	Adjustable 5...13 I _n Non-tripping time ≤ 20 ms		
Instant. I _i	Fixed ≥ 13 I _n		
Unbalance I _d	Fixed 30 %		

Micrologic 2.3

Rating (A)	Type	NSX400	NSX630
	2.3 400	■	■
	2.3 400	■	■
400	2.3 400	■	■
630	2.3 630	-	■
Long time I _r	Adjustable 0.4...1 I _n + fine adjust 0.9...1 via dial		
Short-time I _{sd} , fixed delay	Adjustable 1.5...10 I _n Non-tripping time ≤ 20 ms		
Instant. I _i	Fixed 11 I _n		
4P N protection	Off - 0.5 or 1 I _r		

Alternative with measurements

A: Ammeter

E: Energy

With Micrologic 5.3 A or E, Micrologic 6.3 A or E trip unit

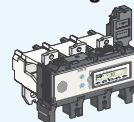

or **Micrologic 5.3 A or E**

Rating (A)	Type	NSX400	NSX630
	-	-	-
	-	-	-
400	5.3 400	■	■
630	5.3 630	-	■
Long time I _r	Adjustable 0.4...1 I _n + fine adjustment 0.9...1 via dial		
Short-time I _{sd} , fixed delay	Adjustable 1.5...10 I _n Adjustable delay 0.1-0.2-0.3-0.4 s + I ² t On/Off		
Instant. I _i	Adjustable 1.5...12 I _n or 15 I _n depending on I _n		
4P N protection	Off - 0.5 or 1 or 1.6 I _n (OSN)		

Micrologic 6.3 A or E

Same as 5.2 + adjust. ground fault protection

I_g 0.2...1 I_n, delay 0...0.4 s + I²t On/off

Micrologic 5.3 A or E
with OSN protection

or **Micrologic 6.3 E-M (Motor)**

Rating (A)	Type	NSX400	NSX630
	6.3-M320	■	■
	6.3-M320	■	■
320	6.3-M320	■	■
500	6.3-M500	-	-
Long time I _r	Adjustable 0.5...1 I _n + fine adjust via keypad		
Class	5, 10, 20, 30		
Short-time I _{sd} , fixed delay	Adjustable 5...13 I _n Non-tripping time ≤ 20 ms		
Instant. I _i	Fixed ≥ 13 I _n		
Unbalance I _d	Ground fault I _g adjustable 0.2...1 I _n , adjustable delay 0...0.4 s + I ² t On/off		

I_d adjustable 10...40 %, delay 0.7...10 s

Locked rotor I_{jam} adjustable Off / 1...8 I_r,
adjustable delay 1...30 s

Under-load I_{und} adjustable Off / 0.3...0.9 I_r,
adjustable delay 1...200 s

Long start I_{long} adjustable Off / 1...8 I_r,
adjustable delay 1...200 s

or **Micrologic 5.3 or 6.3 A or E**

Substitution table

Compatibility of components

Compact NS to NSX

and Compact NSX to NS

Compact NS Cat. number	Designation	Compact NSX Cat. number	Designation	Compatibility	
				NS/NSX	NSX/NS
29000	Basic frame Compact NS100N 100 A 2P fixed		Order a complete breaker with trip unit		
29003	Basic frame Compact NS100N 100 A 3P fixed	LV429003	3P NSX100F without trip unit; Compact circuit breaker		
29004	Basic frame Compact NS100H 100 A 3P fixed	LV429004	3P NSX100H without trip unit; Compact circuit breaker		
29005	NS100L 3P without trip unit	LV429005	3P NSX100L without trip unit; Compact circuit breaker		
29006	NS100 SX 3P without trip unit	LV429006	3P NSX100N without trip unit; Compact circuit breaker		
29008	Basic frame Compact NS100N 100 A 4P fixed	LV429008	4P NSX100F without trip unit; Compact circuit breaker		
29009	NS100H 4P without trip unit	LV429009	4P NSX100H without trip unit; Compact circuit breaker		
29010	NS100L 4P without trip unit	LV429010	4P NSX100L without trip unit; Compact circuit breaker		
29011	NS100 SX 4P without trip unit	LV429011	4P NSX100N without trip unit; Compact circuit breaker		
29020	Trip unit TMD 100 A 3 poles 2d		Order a complete breaker with trip unit	No	No
29021	Trip unit TMD 80 A 3 poles 2d		Order a complete breaker with trip unit	No	No
29022	Trip unit TMD 63 A 3 poles 2d		Order a complete breaker with trip unit	No	No
29023	Trip unit TMD 40 A 3 poles 2d		Order a complete breaker with trip unit	No	No
29024	Trip unit TMD 25 A 3 poles 2d		Order a complete breaker with trip unit	No	No
29025	Trip unit TMD 16 A 3 poles 2d		Order a complete breaker with trip unit	No	No
29026	Trip unit TMD 50 A 3 poles 2d		Order a complete breaker with trip unit	No	No
29027	Trip unit TMD 32 A 3 poles 2d		Order a complete breaker with trip unit	No	No
29030	Trip unit TMD 100 A 3 poles 3d	LV429030	3P3D TM100D trip unit; for NSX100 circuit breaker	No	No
29031	Trip unit TMD 80 A 3 poles 3d	LV429031	3P3D TM80D trip unit; for NSX100 circuit breaker	No	No
29032	Trip unit TMD 63 A 3 poles 3d	LV429032	3P3D TM63D trip unit; for NSX100-250 circuit breaker	No	No
29033	Trip unit TMD 40 A 3 poles 3d	LV429034	3P3D TM40D trip unit; for NSX100-250 circuit breaker	No	No
29034	Trip unit TMD 25 A 3 poles 3d	LV429036	3P3D TM25D trip unit; for NSX100-250 circuit breaker	No	No
29035	Trip unit TMD 16 A 3 poles 3d	LV429037	3P3D TM16D trip unit; for NSX100-250 circuit breaker	No	No
29036	Trip unit TMD 50 A 3 poles 3d	LV429033	3P3D TM50D trip unit; for NSX100-250 circuit breaker	No	No
29037	Trip unit TMD 32 A 3 poles 3d	LV429035	3P3D TM32D trip unit; for NSX100-250 circuit breaker	No	No
29040	Trip unit TMD 100 A 4 poles 3d	LV429040	4P3D TM100D trip unit; for NSX100 circuit breaker	No	No
29041	Trip unit TMD 80 A 4 poles 3d	LV429041	4P3D TM80D trip unit; for NSX100 circuit breaker	No	No
29042	Trip unit TMD 63 A 4 poles 3d	LV429042	4P3D TM63D trip unit; for NSX100-250 circuit breaker	No	No
29043	Trip unit TMD 40 A 4 poles 3d	LV429044	4P3D TM40D trip unit; for NSX100-250 circuit breaker	No	No
29044	Trip unit TMD 25 A 4 poles 3d	LV429046	4P3D TM25D trip unit; for NSX100-250 circuit breaker	No	No
29045	Trip unit TMD 16 A 4 poles 3d	LV429047	4P3D TM16D trip unit; for NSX100-250 circuit breaker	No	No
29046	Trip unit TMD 50 A 4 poles 3d	LV429043	4P3D TM50D trip unit; for NSX100-250 circuit breaker	No	No
29047	Trip unit TMD 32 A 4 poles 3d	LV429045	4P3D TM32D trip unit; for NSX100-250 circuit breaker	No	No
29050	Trip unit TMD 100 A 4 poles 4d	LV429050	4P4D TM100D trip unit; for NSX100 circuit breaker	No	No
29051	Trip unit TMD 80 A 4 poles 4d	LV429051	4P4D TM80D trip unit; for NSX100 circuit breaker	No	No
29052	Trip unit TMD 63 A 4 poles 4d	LV429052	4P4D TM63D trip unit; for NSX100-250 circuit breaker	No	No
29053	Trip unit TMD 40 A 4 poles 4d	LV429054	4P4D TM40D trip unit; for NSX100-250 circuit breaker	No	No
29054	Trip unit TMD 25 A 4 poles 4d	LV429056	4P4D TM25D trip unit; for NSX100-250 circuit breaker	No	No
29055	Trip unit TMD 16 A 4 poles 4d	LV429057	4P4D TM16D trip unit; for NSX100-250 circuit breaker	No	No
29056	Trip unit TMD 50 A 4 poles 4d	LV429053	4P4D TM50D trip unit; for NSX100-250 circuit breaker	No	No
29057	Trip unit TMD 32 A 4 poles 4d	LV429055	4P4D TM32D trip unit; for NSX100-250 circuit breaker	No	No
29060	Trip unit TMD 100 A 4 poles 3d and N and 2	LV429080	4P4D Micrologic 2.2 100 A trip unit; for NSX100-250 circuit breaker	No	No
29061	Trip unit TMD 80 A 4 poles 3d and N and 2	LV429080	4P4D Micrologic 2.2 100 A trip unit; for NSX100-250 circuit breaker	No	No
29070	Trip unit STR22SE 100 A 3 poles 3d	LV429070	3P3D Micrologic 2.2 100 A trip unit; for NSX100-250 circuit breaker	No	No
29072	Trip unit STR22SE 40 A 3 poles 3d	LV429072	3P3D Micrologic 2.2 40 A trip unit; for NSX100-250 circuit breaker	No	No
29075	Trip unit STR22GE 100 A 3 poles 3d	LV429075	3P3D Micrologic 2.2 G 100 A trip unit; for NSX100-250 circuit breaker	No	No
29076	Trip unit STR22GE 40 A 3 poles 3d	LV429076	3P3D Micrologic 2.2 G 40 A trip unit; for NSX100-250 circuit breaker	No	No
29080	Trip unit STR22SE 100 A 4 poles 4d	LV429080	4P4D Micrologic 2.2 100 A trip unit; for NSX100-250 circuit breaker	No	No
29082	Trip unit STR22SE 40 A 4 poles 4d	LV429082	4P4D Micrologic 2.2 40 A trip unit; for NSX100-250 circuit breaker	No	No
29085	Trip unit STR22GE 100 A 4 poles 4d	LV429085	4P4D Micrologic 2.2 G 100 A trip unit; for NSX100-250 circuit breaker	No	No
29086	Trip unit STR22GE 40 A 4 poles 4d	LV429086	4P4D Micrologic 2.2 G 40 A trip unit; for NSX100-250 circuit breaker	No	No
29120	Trip unit MA 100 A 3 poles 3d	LV429120	3P3D MA100 trip unit; for NSX100-250 circuit breaker	No	No
29121	Trip unit MA 50 A 3 poles 3d	LV429121	3P3D MA50 trip unit; for NSX100-250 circuit breaker	No	No
29122	Trip unit MA 25 A 3 poles 3d	LV429122	3P3D MA25 trip unit; for NSX100-250 circuit breaker	No	No
29123	Trip unit MA 12.5 A 3 poles 3d	LV429123	3P3D MA12.5 trip unit; for NSX100-250 circuit breaker	No	No
29124	Trip unit MA 6.3 A 3 poles 3d	LV429124	3P3D MA6.3 trip unit; for NSX100-250 circuit breaker	No	No
29125	Trip unit MA 2.5 A 3 poles 3d	LV429125	3P3D MA2.5 trip unit; for NSX100-250 circuit breaker	No	No
29130	Trip unit MA 100 A 4 poles 3d	LV429130	4P3D MA100 trip unit; for NSX100-250 circuit breaker	No	No
29142	Trip unit TMG 63 A 3 poles 2d		Order a complete breaker with trip unit	No	No
29143	Trip unit TMG 40 A 3 poles 2d		Order a complete breaker with trip unit	No	No
29144	Trip unit TMG 25 A 3 poles 2d		Order a complete breaker with trip unit	No	No
29145	Trip unit TMG 16 A 3 poles 2d		Order a complete breaker with trip unit	No	No
29152	Trip unit TMG 63 A 3 poles 3d	LV429152	3P3D TM63G trip unit; for NSX100-250 circuit breaker	No	No
29153	Trip unit TMG 40 A 3 poles 3d	LV429153	3P3D TM40G trip unit; for NSX100-250 circuit breaker	No	No
29154	Trip unit TMG 25 A 3 poles 3d	LV429154	3P3D TM25G trip unit; for NSX100-250 circuit breaker	No	No

Compact NS Cat. number	Designation	Compact NSX Cat. number	Designation	Compatibility	
				NS/NSX	NSX/NS
29155	Trip unit TMG 16 A 3 poles 3d	LV429155	3P3D TM16G trip unit; for NSX100-250 circuit breaker	No	No
29162	Trip unit TMG 63 A 4 poles 4d	LV429162	4P4D TM63G trip unit; for NSX100-250 circuit breaker	No	No
29163	Trip unit TMG 40 A 4 poles 4d	LV429163	4P4D TM40G trip unit; for NSX100-250 circuit breaker	No	No
29164	Trip unit TMG 25 A 4 poles 4d	LV429164	4P4D TM25G trip unit; for NSX100-250 circuit breaker	No	No
29165	Trip unit TMG 16 A 4 poles 4d	LV429165	4P4D TM16G trip unit; for NSX100-250 circuit breaker	No	No
29170	Trip unit STR22ME 100 A 3 poles 3d	LV429170	3P3D Micrologic 2.2 M 100 A trip unit; for NSX100-250 circuit breaker	No	No
29171	Trip unit STR22ME 80 A 3 poles 3d			No	
29172	Trip unit STR22ME 50 A 3 poles 3d	LV429172	3P3D Micrologic 2.2 M 50 A trip unit; for NSX100-250 circuit breaker	No	No
29173	Trip unit STR22ME 40 A 3 poles 3d			No	
29174	Trip unit STR22ME 25 A 3 poles 3d	LV429174	3P3D Micrologic 2.2 M 25 A trip unit; for NSX100-250 circuit breaker	No	No
29175	Trip unit STR22ME 20 A 3 poles 3d			No	
29200	Non automatic trip unit 2P (NS100/250)		Order a complete breaker with trip unit	No	No
29201	Non automatic trip unit 3P (NS100/250)		Order a complete breaker with trip unit	No	No
29202	Non automatic trip unit 4P (NS100/250)		Order a complete breaker with trip unit	No	No
29210	Earthleakage module Compact Vigi MH 3P 200 to 440 V 30 to 10000 mA	LV429210	3P 200-440 V AC 0.03-10 A Vigi MH; earth-leakage prot. for NSX100/160 breaker	No	No
29211	Earthleakage module Compact Vigi MH 4P 200 to 440 V 30 to 10000 mA	LV429211	4P 200-440 V AC 0.03-10 A Vigi MH; earth-leakage prot. for NSX100/160 breaker	No	No
29212	Earthleakage module Compact Vigi ME 3P 200 to 440 V 300 mA	LV429212	3P 200-440 V AC 0.3 A Vigi ME; earth-leakage prot. for NSX100/160 breaker	No	No
29213	Earthleakage module Compact Vigi ME 4P 200 to 440 V 300 mA	LV429213	4P 200-440 V AC 0.3 A Vigi ME; earth-leakage prot. for NSX100/160 breaker	No	No
29214	Connection for a 4P VIGI on a 3P breaker (NS100/630)	LV429214	Connection for 4P Vigi on 3P device; 3P NSX100-250 circuit breaker accessory	Yes	Yes
29215	Earthleakage module Compact Vigi MH 3P 440 to 550 V 30 to 10000 mA	LV429215	3P 440-550 V AC 0.03-10 A Vigi MH; earth-leakage prot. for NSX100/160 breaker	No	No
29216	Earthleakage module Compact Vigi MH 4P 440 to 550 V 30 to 10000 mA	LV429216	4P 440-550 V AC 0.03-10 A Vigi MH; earth-leakage prot. for NSX100/160 breaker	No	No
29227	3 bare cable connectors 25 to 95 mm ² (NS100/250)	LV429227	3 connectors (1 x 25-95 mm ²); INV/INS NSX100-250 circuit breaker accessory	Yes	Yes
29228	4 bare cable connectors 25 to 95 mm ² (NS100/250)	LV429228	4 connectors (1 x 25-95 mm ²); INV/INS NSX100-250 circuit breaker accessory	Yes	Yes
29234	12 clip-on nuts M6 FC (NS100/250)	LV429234	12 M6 snap-in nuts for front connection; NSX100 circuit breaker accessory	Yes	Yes
29235	Rear connection short for NS100 to 250	LV429235	2 short rear connections; INV/INS NSX100-250 circuit breaker accessory	Yes	Yes
29236	Rear connection long for NS100 to 250	LV429236	2 long rear connections; INV/INS NSX100-250 circuit breaker accessory	Yes	Yes
29237	Rear connection short for NS100 to 250 3P		Different packaging	Yes	
29238	Rear connection short for NS100 to 250 4P		Different packaging	Yes	
29241	1 bag of 10 clips for connectors (NS100/250)	LV429241	10 clips for connectors; INV/INS NSX100-250 circuit breaker accessory	Yes	Yes
29242	3 shrouded cable connectors 160 A (NS100/160)	LV429242	3 steel connectors (1x 1.5-95 mm ²); INV/INS NSX100-250 circuit breaker accessory	Yes	Yes
29243	4 shrouded cable connectors 160 A (NS100/160)	LV429243	4 steel connectors (1x 1.5-95 mm ²); INV/INS NSX100-250 circuit breaker accessory	Yes	Yes
29248	3 connect. 6 cables 35 mm ² and ph. sep (NS100/250)	LV429248	3 connectors (6 x 1.5-35 mm ²) + ph barriers; INV/INS NSX100-250 breaker accessory	Yes	Yes
29249	4 connect. 6 cables 35 mm ² and ph. sep (NS100/250)	LV429249	4 connectors (6 x 1.5-35 mm ²) + ph barriers; INV/INS NSX100-250 breaker accessory	Yes	Yes
29252	3 tubular lugs for cable 120 mm ² 8-25 and 2 separators (NS100/250)	LV429252	3 Cu 120 mm ² crimp lugs + ph barriers; INV/INS NSX100-250 breaker accessory	Yes	Yes
29253	3 tubular lugs for copper cable 1500 mm ² and separators (NS100/250)	LV429253	3 Cu 120 mm ² crimp lugs + ph barriers; INV/INS NSX100-250 breaker accessory	Yes	Yes
29254	3 tubular lugs for copper cable 185 mm ² and 2 separators (NS100/250)	LV429254	3 Cu 185 mm ² crimp lugs + ph barriers; INV/INS NSX100-250 breaker accessory	Yes	Yes
29256	4 tubular lugs for copper cable 120 mm ² and 3 separators (NS100/250)	LV429256	4 Cu 120 mm ² crimp lugs + ph barriers; INV/INS NSX100-250 breaker accessory	Yes	Yes
29257	4 tubular lugs for copper cable 150 mm ² and separators (NS100/250)	LV429257	4 Cu 150 mm ² crimp lugs + ph barriers; INV/INS NSX100-250 breaker accessory	Yes	Yes
29258	4 tubular lugs for copper cable 185 mm ² and 3 separators (NS100/250)	LV429258	4 Cu 185 mm ² crimp lugs + ph barriers; INV/INS NSX100-250 breaker accessory	Yes	Yes
29259	3 bare cable connectors 120 to 185 mm ² (NS100/250)	LV429259	3 connectors (1 x 120-185 mm ²); INV/INS NSX100-250 circuit breaker accessory	Yes	Yes
29260	4 bare cable connectors 120 to 185 mm ² (NS100/250)	LV429260	4 connectors (1 x 120-185 mm ²); INV/INS NSX100-250 circuit breaker accessory	Yes	Yes
29261	Terminal extension rightangle connection for NS100 to 250 3P	LV429261	3 right angle terminal ext + ph barriers; INV/INS NSX100-250 breaker accessory	Yes	Yes
29262	Terminal extension rightangle connection for NS100 to 250 4P	LV429262	4 right angle terminal ext + ph barriers; INV/INS NSX100-250 breaker accessory	Yes	Yes
29263	Terminal extension set of 3 for NS100 to 250	LV429263	3 straight terminal ext + ph barriers; INV/INS NSX100-250 breaker accessory	Yes	Yes
29264	Terminal extension set of 4 for NS100 to 250	LV429264	4 straight terminal ext + ph barriers; INV/INS NSX100-250 breaker accessory	Yes	Yes
29265	Plug-in base F/R connected 2P (NS100/250)	LV429265	2P plug-in base; NSX100-250 circuit breaker accessory		

Substitution table

Compatibility of components

Compact NS to NSX

and Compact NSX to NS

Compact NS Cat. number	Designation	Compact NSX Cat. number	Designation	Compatibility	
				NS/NSX	NSX/NS
29266	Plug-in base F/R connected 3P (NS100/250)	LV429266	3P plug-in base; NSX100-250 circuit breaker accessory	Yes	No
29267	Plug-in base F/R connected 4P (NS100/250)	LV429267	4P plug-in base; NSX100-250 circuit breaker accessory	Yes	No
29268	Stud for drawout installation set of 2 for NS100 to 250	LV429268	2 plug-in base power connections; NSX100-250 circuit breaker accessory	No	No
29269	Stud for drawout installation set of 2 for Vigi NS100 to 250	LV429269	2 Vigi plug-in base power connections; NSX100-250 circuit breaker accessory	No	No
29270	Trip interlock link (NS100/250)	LV429270	Safety trip for advanced opening; NSX100-250 circuit breaker accessory	Yes	Yes
29271	2 shutters IP40 for plug-in base 1P (NS100/250)	LV429271	2 IP40 shutters for plug-in base; NSX100-250 circuit breaker accessory	Yes	Yes
29272	Auxiliary cable plug and socket for 9 cables (NS100/250)	LV429272	9-wire auxiliary connector; NSX100-630 circuit breaker accessory	Yes	Yes
29273	Fixed 9 cable connection block (NS100/630)	LV429273	1 x 9-wire fixed connector for base; NSX100-630 circuit breaker accessory	Yes	Yes
29274	Moving 9 cable connection block (NS100/250)	LV429274	1 x 9-wire moving connector for breaker; NSX100-630 circuit breaker accessory	Yes	Yes
29275	Support for moving cable block (NS100/250)	LV429275	1 support for 2 moving connectors; NSX100-250 circuit breaker accessory	Yes	Yes
29276	Terminal extension insulated long for plug in base NS100 to 250 3P	LV429276	2 long insulated terminal ext for base; NSX100-250 circuit breaker accessory	Yes	Yes
29282	Withdrawable chassis (fixed part) (NS100/250)	LV429282	Chassis side plates for 3/4P base; NSX100-250 circuit breaker accessory	Yes	Yes
29283	Withdrawable chassis (moving part) (NS100/250)	LV429283	Chassis side plates for 3/4P breaker; NSX100-250 circuit breaker accessory	Yes	Yes
29284	Extension escutcheon (D/O chassis) (NS100/250)	LV429284	Escutcheon collar for toggle (chassis); NSX100-250 circuit breaker accessory	Yes	Yes
29285	Extension escutcheon (D/O VIGI) (NS100/630)	LV429285	Escutcheon collar for Vigi (chassis); NSX100-630 circuit breaker accessory	Yes	Yes
29286	Chassis rack. Interlock (w/o lock (NS100/630)	LV429286	Chassis locking kit (without keylock); NSX100-630 circuit breaker accessory	Yes	Yes
29287	2 connected/disconnected position C/O sw.	LV429287	2 carriage switches (connect/disconnect); NSX100-630 circuit breaker accessory	Yes	Yes
29288	Complete set for plug-in 2P (NS100/250)	LV429288	2P (3P) Compact plug-in base kit; NSX100-250 circuit breaker accessory		
29289	Complete set for plug-in 3P (NS100/250)	LV429289	3P Compact plug-in base kit; NSX100-250 circuit breaker accessory		
29290	Complete set for plug-in 4P (NS100/250)	LV429290	4P Compact plug-in base kit; NSX100-250 circuit breaker accessory		
29291	Complete set for VIGI into plug-in 3P (NS100/250)	LV429291	3P Vigi compact plug-in kit; NSX100-250 circuit breaker accessory		
29292	Complete set for VIGI into plug-in 4P (NS100/250)	LV429292	4P Vigi compact plug-in kit; NSX100-250 circuit breaker accessory		
29298	Complete set for drawout 2P (NS100/250)		Different packaging		
29299	Complete set for draw out 3P (NS100/250)		Different packaging		
29300	Complete set for draw out 4P (NS100/250)		Different packaging		
29301	Complete set for VIGI into draw out 3P (NS100/250)		Different packaging		
29302	Complete set for VIGI into draw out 4P (NS100/250)		Different packaging		
29305	Din rail adapter (NS100/250)	LV429305	Din rail adapter; NSX100-250 circuit breaker accessory	Yes	Yes
29306	3P terminal shields adap. for plug-in base set of 2 NS100/250		Different packaging	Yes	
29307	4P terminal shields adap. for plug-in base set of 2 NS100/250		Different packaging	Yes	
29308	2 long terminal shields 3P for plug-in base (NS100/250)		Different packaging	Yes	
29309	2 long terminal shields 4P for plug-in base (NS100/250)		Different packaging	Yes	
29312	Screws (NS100 to 250)	LV429312	Bag of screws for Compact NSX100-250; INV/INS NSX100-250 breaker accessory	Yes	Yes
29313	10 toggle extensions (NS250)	LV429313	10 toggle extensions; NSX100-250 circuit breaker accessory	Yes	Yes
29315	Escutcheon for direct toggle (NS100/250)			No	
29316	Escutcheon for Vigi (NS100/250)	LV429316	IP40 escutcheon for Vigi module; NSX100-250 circuit breaker accessory	Yes	Yes
29317	Escutcheon (motor mech./rot. handle) (NS100/250)	LV429317	IP40 escutcheon all control types; NSX100-250 circuit breaker accessory	Yes	Yes
29318	Escutcheon for ammeter/Vigi (NS100/630)	LV429318	IP40 escutcheon for ammeter or Vigi; INV/INS NSX100-630 breaker accessory	Yes	Yes
29319	Rubber toggle cover (IP43) (NS100/250)	LV429319	IP43 rubber toggle cover; NSX100-250 circuit breaker accessory	No	No
29321	2 short terminal shields 3P (NS100/250)		Different packaging	Yes	
29322	2 short terminal shields 4P (NS100/250)		Different packaging	Yes	
29323	2 long terminal shields 3P (NS100/250)		Different packaging	Yes	
29324	2 long terminal shields 4P (NS100/250)		Different packaging	Yes	
29325	Voltage indicator	LV429325	220-550 V AC voltage indicator; NSX100-250 circuit breaker accessory	Yes	Yes
29326	2 long term. shields 3P U > 600 V (NS100/NS250)		Different packaging	Yes	
29327	2 long term. shields 4P U > 600 V (NS100/NS250)		Different packaging	Yes	

Compact NS Cat. number	Designation	Compact NSX Cat. number	Designation	Compatibility	
				NS/NSX	NSX/NS
29329	6 interphase barriers (NS100/250)	LV429329	6 interphase barriers; INV/INS NSX100-250 circuit breaker accessory	Yes	Yes
29330	2 rear insulators 3P (NS100/250)	LV429330	2 insulating screens 3P (45 mm pitch); NSX100-250 circuit breaker accessory	Yes	Yes
29331	2 rear insulators 4P (NS100/250)	LV429331	2 insulating screens 4P (45 mm pitch); NSX100-250 circuit breaker accessory	Yes	Yes
29332	Long terminal shields and 3P adaptor for plug-in base (NS100/250)		Different packaging	Yes	
29333	Long terminal shields and 4P adaptor for plug-in base (NS100/250)		Different packaging	Yes	
29334	Phase barriers and 3P adaptor for plug-in base (NS100/250)		Different packaging	Yes	
29335	Extended rotary handle and telescopic shaft blokset (NS100/250)	LV429343	Blokset telescopic rotary handle; NSX100-250 circuit breaker accessory	No	Yes
29336	Early make wiring terminal (NS80/630)			Yes	
29337	Front rotary handle NS100 to 250 black handle	LV429337	Direct standard rotary handle; NSX100-250 circuit breaker accessory	No	Yes
29338	Front rotary handle NS100 to 250 black handle	LV429338	Extended standard rotary handle; NSX100-250 circuit breaker accessory	No	Yes
29339	Front rotary handle NS100 to 250 red handle	LV429339	Direct red-yellow rotary handle; NSX100-250 circuit breaker accessory	No	Yes
29340	Front rotary handle NS100 to 250 red handle	LV429340	Extended red-yellow rotary handle; NSX100-250 circuit breaker accessory	No	Yes
29341	Accessory for MCC type rotary handle (NS100/250)	LV429341	Rotary handle MCC conversion accessory; NSX100-250 circuit breaker accessory	Yes	Yes
29342	CNOMO accessory for rotary handle (NS100/250)	LV429342	Rotary handle CNOMO conversion accessory; NSX100-250 circuit breaker accessory	No	Yes
29343	Front rotary handle NS100 to 250 black handle	LV429343	Telescopic rotary handle (500 mm shaft); NSX100-250 circuit breaker accessory	No	Yes
29344	Rotary handle lock support (w/o lock) (NS100/250)	LV429344	Rotary handle keylock adapter (w/o keylock); NSX100-250 circuit breaker accessory	Yes	Yes
29345	Auxiliary contact 1 OC earlybreak	LV429345	1 early-brake contact; NSX100-250 circuit breaker accessory	No	Yes
29346	Auxiliary contact 2 OC earlymake	LV429346	2 early-make contacts; NSX100-250 circuit breaker accessory	No	Yes
29348	2 voltage take off aluminium LUGNS250/630	LV429348	10 voltage take-offs for connectors; INV/INS NSX100-630 breaker accessory	Yes	Yes
29349	Base plate with mechanical interlocking Compact NS100 to 250		NSX cat. number same as NS cat. number	Yes	
29350	Base plate with mechanical and electrical interlocking Compact NS100 to 250		NSX cat. number same as NS cat. number	Yes	
29351	Base plate with mechanical and electrical interlocking Compact NS100 to 250		NSX cat. number same as NS cat. number	Yes	
29352	Electrical interlocking IVE 48 to 415 V AC 50 and 60 Hz		NSX cat. number same as NS cat. number	Yes	
29354	Interlocking for devices with toggle Compact NS100 to 250	LV429354	Mechanical interlock for toggles; NSX100-250 circuit breaker accessory	No	No
29356	Electrical interlocking IVE 24 to 250 V DC		NSX cat. number same as NS cat. number	Yes	
29358	Accessory for sourcechangeover switch downstream 3P busbar coupling, 250 A		NSX cat. number same as NS cat. number	Yes	
29359	Accessory for sourcechangeover switch downstream 4P busbar coupling, 250 A		NSX cat. number same as NS cat. number	Yes	
29363	Interface for automatic controller ACP 220 to 240 V		NSX cat. number same as NS cat. number	Yes	
29364	Interface for automatic controller ACP 380 to 415 V		NSX cat. number same as NS cat. number	Yes	
29368	Cable connection IVE/BA-UA		NSX cat. number same as NS cat. number	Yes	
29369	Interlocking for devices with rotary handle Compact NS100 to 250	LV429369	Mechanical interlock for rot handles; INV/INS NSX100-250 circuit breaker accessory	Yes	Yes
29370	Removable toggle padlock. device (NS80/630)			Yes	
29371	Fixed toggle padlock. device (NS100/250)	LV429371	Fixed locking device for 3 padlocks; NSX100-250 circuit breaker accessory	No	Yes
29375	Complete sealing kit (NS80/630)	LV429375	Lead-sealing accessories; INV/INS NS80-NSX630 circuit breaker accessory	Yes	Yes
29376	Automatic controller BA 220 to 240 V		NSX cat. number same as NS cat. number	Yes	
29377	Automatic controller BA 380 to 415 V		NSX cat. number same as NS cat. number	Yes	
29378	Automatic controller UA 220 to 240 V		NSX cat. number same as NS cat. number	Yes	
29379	Automatic controller UA with communication 220 to 240 V		NSX cat. number same as NS cat. number	Yes	
29380	Automatic controller UA 380 to 415 V		NSX cat. number same as NS cat. number	Yes	
29381	Automatic controller UA with communication 380 to 415 V		NSX cat. number same as NS cat. number	Yes	
29382	Shunt trip Compact MX 12 V DC	LV429382	MX 12 V DC shunt release; NSX100-630 circuit breaker accessory	Yes	Yes
29383	Shunt trip Compact MX 60 V DC	LV429383	MX 60 V DC shunt release; NSX100-630 circuit breaker accessory	Yes	Yes
29384	Shunt trip Compact MX 24 V AC at 50 and 60 Hz	LV429384	MX 24 V 50/60 Hz shunt release; NSX100-630 circuit breaker accessory	Yes	Yes
29385	Shunt trip Compact MX 48 V AC at 50 and 60 Hz	LV429385	MX 48 V 50/60 Hz shunt release; NSX100-630 circuit breaker accessory	Yes	Yes
29386	Shunt trip Compact MX 110 to 130 V AC at 50 and 60 Hz	LV429386	MX 110-130 V 50/60 Hz shunt release; NSX100-630 circuit breaker accessory	Yes	Yes

Substitution table

Compatibility of components

Compact NS to NSX

and Compact NSX to NS

Compact NS Cat. number	Designation	Compact NSX Cat. number	Designation	Compatibility	
				NS/NSX	NSX/NS
29387	Shunt trip Compact MX 220 to 240 V AC at 50 and 60 Hz	LV429387	MX 220-240 V 50/60 Hz 208-277 V 60 Hz SHT; NSX100-630 breaker accessory	Yes	Yes
29388	Shunt trip Compact MX 380 to 415 V AC at 50 Hz	LV429388	MX 380-415 V 50/60 Hz 440-480 V 60 Hz SHT; NSX100-630 breaker accessory	Yes	Yes
29389	Shunt trip Compact MX 525 V AC at 50 Hz	LV429389	MX 525 V 50 Hz 600 V 60 Hz shunt release; NSX100-630 circuit breaker accessory	Yes	Yes
29390	Shunt trip Compact MX 24 V DC	LV429390	MX 24 V DC shunt release; NSX100-630 circuit breaker accessory	Yes	Yes
29391	Shunt trip Compact MX 30 V DC	LV429391	MX 30 V DC shunt release; NSX100-630 circuit breaker accessory	Yes	Yes
29392	Shunt trip Compact MX 48 V DC	LV429392	MX 48 V DC shunt release; NSX100-630 circuit breaker accessory	Yes	Yes
29393	Shunt trip Compact MX 125 V DC	LV429393	MX 125 V DC shunt release; NSX100-630 circuit breaker accessory	Yes	Yes
29394	Shunt trip Compact MX 250 V DC	LV429394	MX 250 V DC shunt release; NSX100-630 circuit breaker accessory	Yes	Yes
29400	MX24 V AC/DC	LV429400	MX 24 V DC/AC shunt release; NSX100-630 circuit breaker accessory	Yes	Yes
29402	Voltage release Compact MN 12 V DC	LV429402	MN 12 V DC undervoltage release; NSX100-630 circuit breaker accessory	Yes	Yes
29403	Voltage release Compact MN 60 V DC	LV429403	MN 60 V DC undervoltage release; NSX100-630 circuit breaker accessory	Yes	Yes
29404	Voltage release Compact MN 24 V AC 50 and 60 Hz	LV429404	MN 24 V 50/60 Hz undervoltage release; NSX100-630 circuit breaker accessory	Yes	Yes
29405	Voltage release Compact MN 48 V AC 50 and 60 Hz	LV429405	MN 48 V 50/60 Hz undervoltage release; NSX100-630 circuit breaker accessory	Yes	Yes
29406	Voltage release Compact MN 110 to 130 V AC 50 and 60 Hz	LV429406	MN 110-130 V 50/60 Hz undervoltage release; NSX100-630 circuit breaker accessory	Yes	Yes
29407	Voltage release Compact MN 220 to 240 V AC 50 and 60 Hz	LV429407	MN 220-240 V 50/60 Hz 208-277 V 60 Hz UVR; NSX100-630 circuit breaker accessory	Yes	Yes
29408	Voltage release Compact MN 380 to 415 V AC 50 Hz	LV429408	MN 380-415 V 50/60 Hz 440-480 V 60 Hz UVR; NSX100-630 circuit breaker accessory	Yes	Yes
29409	Voltage release Compact MN 525 V AC 50 Hz	LV429409	MN 525 V 50 Hz 600 V 60 Hz UVR; NSX100-630 circuit breaker accessory	Yes	Yes
29410	Voltage release Compact MN 24 V DC	LV429410	MN 24 V DC undervoltage release; NSX100-630 circuit breaker accessory	Yes	Yes
29411	Voltage release Compact MN 30 V DC	LV429411	MN 30 V DC undervoltage release; NSX100-630 circuit breaker accessory	Yes	Yes
29412	Voltage release Compact MN 48 V DC	LV429412	MN 48 V DC undervoltage release; NSX100-630 circuit breaker accessory	Yes	Yes
29413	Voltage release Compact MN 125 V DC	LV429413	MN 125 V DC undervoltage release; NSX100-630 circuit breaker accessory	Yes	Yes
29414	Voltage release Compact MN 250 V DC	LV429414	MN 250 V DC undervoltage release; NSX100-630 circuit breaker accessory	Yes	Yes
29424	Early thermal fault signal 110/240 V AC/DC	LV429424	SDTAM 24/415 V AC/DC thermal fault module; NSX100-630 trip unit accessory	No	No
29426	Uvr, time delay realy 48 V 50 Hz (NS80/NS630)	LV429426	48 V AC 50/60 Hz MN delay unit; NSX100-630 circuit breaker accessory	Yes	Yes
29427	Uvr, time delay realy 220/240 V AC 50 Hz (NS80/C1251)	LV429427	220-240 V AC 50/60 Hz MN delay unit; NS80-NSX630 circuit breaker accessory	Yes	Yes
29430	Early thermal fault signal 24/48 V AC 24/72 V DC	LV429424	SDTAM 24/415 V AC/DC thermal fault module; NSX100-630 trip unit accessory	No	
29433	Motor mechanism Compact MT100 and 160 48 to 60 V AC	LV429433	110-130 V AC 50/60 Hz MT100/160; NSX100/160 circuit breaker motor mech. module	No	Yes
29434	Motor mechanism Compact MT100 and 160 220 to 240 V AC	LV429434	220-240 V 50/60 Hz 208-277 V 60 Hz MT100/160; NSX100/160 breaker motor mech. module	No	Yes
29435	Motor mechanism Compact MT100 and 160 380 to 415 V AC	LV429435	380-415 V 50/60 Hz 440-480 V 60 Hz MT100/160; NSX100/160 breaker motor mech. module	No	Yes
29436	Motor mechanism Compact MT100 and 160 24 to 30 V DC	LV429436	24-30 V DC MT100/160; NSX100/160 circuit breaker motor mech. module	No	Yes
29437	Motor mechanism Compact MT100 and 160 48 to 60 V DC	LV429437	48-60 V DC MT100/160; NSX100/160 circuit breaker motor mech. module	No	Yes
29438	Motor mechanism Compact MT100 and 160 110 to 130 V DC	LV429438	110-130 V DC MT100/160; NSX100/160 circuit breaker motor mech. module	No	Yes
29439	Motor mechanism Compact MT100 and 160 250 V DC	LV429439	250 V DC MT100/160; NSX100/160 circuit breaker motor mech. module	No	Yes
29440	Motor mechanism Compact MT100 and 160 48 to 60 V AC	LV429440	48-60 V AC 50/60 Hz MT100/160; NSX100/160 circuit breaker motor mech. module	No	Yes
29441	Motor mechanism Compact MT100 and 160 220 to 240 V AC	LV429441	Communicating 220-240 V 50/60 Hz MT100/160; NSX100/160 breaker motor mech. module	No	No
29446	Automatic controller UA 110 to 127 V		NSX cat. number same as NS cat. number	Yes	
29447	Interface for automatic controller ACP 110 to 127 V		NSX cat. number same as NS cat. number	Yes	
29448	Interface and automatic controller ACP and UA 110 to 127 V		NSX cat. number same as NS cat. number	Yes	
29449	Motor mechanism lock (keylock supplied) (NS100/250)	LV429449	Motor mech. keylock adapter + keylock; NSX100-250 circuit breaker accessory	Yes	Yes
29450	Auxiliary contact 1 OC or 1 SD or 1 SDE or 1 SDV		NSX cat. number same as NS cat. number	Yes	

Compact NS Cat. number	Designation	Compact NSX Cat. number	Designation	Compatibility	
				NS/NSX	NSX/NS
29451	SDE accessory for TM/MA trip unit (NS100/250)	LV429451	SDE adapter for trip unit; NSX100-250 circuit breaker accessory	No	No
29452	Auxiliary contact 1 OC or 1 SD or 1 SDE or 1 SDV low level		NSX cat. number same as NS cat. number	Yes	Yes
29453	Auxiliary contact 1 OC and 1 SD and 1 SDE communicating		Replaced by BSCM	No	No
29455	Ammeter module for NS100 3P 100 A	LV429455	3P 100 A ammeter module; NSX100-250 circuit breaker accessory	No	No
29456	Ammeter module for NS100 4P 100 A	LV429456	4P 100 A ammeter module; INV/INS NSX100-250 circuit breaker accessory	No	No
29457	Current transformer module for NS100 3P 100 A	LV429457	3P 100/5 A current transfo module; NSX100-250 circuit breaker accessory	No	No
29458	Current transformer module for NS100 4P 100 A	LV429458	4P 100/5 A current transfo module; INV/INS NSX100-250 circuit breaker accessory	No	No
29459	Insulation monitoring module for NS100 to 250 3P	LV429459	3P TNS/TT insulation monitoring module; NSX100-250 circuit breaker accessory	No	No
29460	Insulation monitoring module for NS100 to 250 4P	LV429460	4P TNS/TT insulation monitoring module; NSX100-250 circuit breaker accessory	No	No
29461	CT module 3P 3CT 125 A/5 A with voltage outputs	LV429461	3P 125/5 A CT module + voltage outputs; NSX100-250 circuit breaker accessory	No	No
29462	CT module 4P 3CT 125 A/5 A with voltage outputs	LV429462	4P 125/5 A CT module + voltage outputs; NSX100-250 circuit breaker accessory	No	No
29465	Weatherproof enclosure for Compact NS100 to 160 plastic	LV429465	Insulating enclosure + standard extended rotary handle; NSX100/160 IP55 enclosure	Yes	
29466	Weatherproof enclosure for Vigicompact NS100 to 160 plastic	LV429466	Insulating enclosure + standard extended rotary handle; Vigi NSX100/160 IP55 enclosure	Yes	
29470	Interface and automatic controller ACP and BA 220 to 240 V		NSX cat. number same as NS cat. number	Yes	
29471	Interface and automatic controller ACP and BA 380 to 415 V		NSX cat. number same as NS cat. number	Yes	
29472	Interface and automatic controller ACP and UA 220 to 240 V		NSX cat. number same as NS cat. number	Yes	
29473	Interface and automatic controller ACP and UA 380 to 415 V		NSX cat. number same as NS cat. number	Yes	
29474	Interface and automatic controller ACP and UA with communication 220 to 240 V		NSX cat. number same as NS cat. number	Yes	
29475	Interface and automatic controller ACP and UA with communication 380 to 415 V		NSX cat. number same as NS cat. number	Yes	
29504	3 bimetallic lugs for alu cable 150 mm ² and 2 sep (NS100/250)	LV429504	3 Al 150 mm ² crimp lugs + ph barriers; INV/INS NSX100-250 breaker accessory	Yes	Yes
29505	4 bimetallic lugs for alu cable 150 mm ² and 3 sep (NS100/250)	LV429505	4 Al 150 mm ² crimp lugs + ph barriers; INV/INS NSX100-250 breaker accessory	Yes	Yes
29506	3 bimetallic lugs for alu cable 185 mm ² and 2 sep (NS100/250)	LV429506	3 Al 185 mm ² crimp lugs + ph barriers; INV/INS NSX100-250 breaker accessory	Yes	Yes
29507	4 bimetallic lugs for alu cable 185 mm ² and 3 sep (NS100/250)	LV429507	4 Al 185 mm ² crimp lugs + ph barriers; INV/INS NSX100-250 breaker accessory	Yes	Yes
29619	Molded case switch-disconnector Compact NS100 NA 2P 100 A	LV429619	2P (3P) NSX100NA; Compact switch-disconnector		
29620	Circuit breaker Compact NS100N TMD 100 A 3P 2d	LV429620	3P2D TM100D NSX100F; Compact circuit breaker		
29621	Circuit breaker Compact NS100N TMD 80 A 3P 2d	LV429621	3P2D TM80D NSX100F; Compact circuit breaker		
29622	Circuit breaker Compact NS100N TMD 63 A 3P 2d	LV429622	3P2D TM63D NSX100F; Compact circuit breaker		
29623	Circuit breaker Compact NS100N TMD 40 A 3P 2d	LV429624	3P2D TM40D NSX100F; Compact circuit breaker		
29624	Circuit breaker Compact NS100N TMD 25 A 3P 2d	LV429626	3P2D TM25D NSX100F; Compact circuit breaker		
29625	Circuit breaker Compact NS100N TMD 16 A 3P 2d	LV429627	3P2D TM16D NSX100F; Compact circuit breaker		
29626	Circuit breaker Compact NS100N TMD 50 A 3P 2d	LV429623	3P2D TM50D NSX100F; Compact circuit breaker		
29627	Circuit breaker Compact NS100N TMD 32 A 3P 2d	LV429625	3P2D TM32D NSX100F; Compact circuit breaker		
29629	Molded case switch-disconnector Compact NS100 NA 3P 100 A	LV429629	3P NSX100NA; Compact switch-disconnector		
29630	Circuit breaker Compact NS100N TMD 100 A 3P 3d	LV429630	3P3D TM100D NSX100F; Compact circuit breaker		
29631	Circuit breaker Compact NS100N TMD 80 A 3P 3d	LV429631	3P3D TM80D NSX100F; Compact circuit breaker		
29632	Circuit breaker Compact NS100N TMD 63 A 3P 3d	LV429632	3P3D TM63D NSX100F; Compact circuit breaker		
29633	Circuit breaker Compact NS100N TMD 40 A 3P 3d	LV429634	3P3D TM40D NSX100F; Compact circuit breaker		
29634	Circuit breaker Compact NS100N TMD 25 A 3P 3d	LV429636	3P3D TM25D NSX100F; Compact circuit breaker		
29635	Circuit breaker Compact NS100N TMD 16 A 3P 3d	LV429637	3P3D TM16D NSX100F; Compact circuit breaker		
29636	Circuit breaker Compact NS100N TMD 50 A 3P 3d	LV429633	3P3D TM50D NSX100F; Compact circuit breaker		
29637	Circuit breaker Compact NS100N TMD 32 A 3P 3d	LV429635	3P3D TM32D NSX100F; Compact circuit breaker		
29639	Molded case switch-disconnector Compact NS100 NA 4P 100 A	LV429639	4P NSX100NA; Compact switch-disconnector		
29640	Circuit breaker Compact NS100N TMD 100 A 4P 3d	LV429640	4P3D TM100D NSX100F; Compact circuit breaker		
29641	Circuit breaker Compact NS100N TMD 80 A 4P 3d	LV429641	4P3D TM80D NSX100F; Compact circuit breaker		
29642	Circuit breaker Compact NS100N TMD 63 A 4P 3d	LV429642	4P3D TM63D NSX100F; Compact circuit breaker		
29643	Circuit breaker Compact NS100N TMD 40 A 4P 3d	LV429644	4P3D TM40D NSX100F; Compact circuit breaker		
29644	Circuit breaker Compact NS100N TMD 25 A 4P 3d	LV429646	4P3D TM25D NSX100F; Compact circuit breaker		
29645	Circuit breaker Compact NS100N TMD 16 A 4P 3d	LV429647	4P3D TM16D NSX100F; Compact circuit breaker		
29646	Circuit breaker Compact NS100N TMD 50 A 4P 3d	LV429643	4P3D TM50D NSX100F; Compact circuit breaker		
29647	Circuit breaker Compact NS100N TMD 32 A 4P 3d	LV429645	4P3D TM32D NSX100F; Compact circuit breaker		

Substitution table

Compatibility of components

Compact NS to NSX

and Compact NSX to NS

Compact NS Cat. number	Designation	Compact NSX Cat. number	Designation	Compatibility	
				NS/NSX	NSX/NS
29650	Circuit breaker Compact NS100N TMD 100 A 4P 4d	LV429650	4P4D TM100D NSX100F; Compact circuit breaker		
29651	Circuit breaker Compact NS100N TMD 80 A 4P 4d	LV429651	4P4D TM80D NSX100F; Compact circuit breaker		
29652	Circuit breaker Compact NS100N TMD 63 A 4P 4d	LV429652	4P4D TM63D NSX100F; Compact circuit breaker		
29653	Circuit breaker Compact NS100N TMD 40 A 4P 4d	LV429654	4P4D TM40D NSX100F; Compact circuit breaker		
29654	Circuit breaker Compact NS100N TMD 25 A 4P 4d	LV429656	4P4D TM25D NSX100F; Compact circuit breaker		
29655	Circuit breaker Compact NS100N TMD 16 A 4P 4d	LV429657	4P4D TM16D NSX100F; Compact circuit breaker		
29656	Circuit breaker Compact NS100N TMD 50 A 4P 4d	LV429653	4P4D TM50D NSX100F; Compact circuit breaker		
29657	Circuit breaker Compact NS100N TMD 32 A 4P 4d	LV429655	4P4D TM32D NSX100F; Compact circuit breaker		
29660	Circuit breaker Compact NS100N TMD 100 A 4P 3d and N/2		Replaced by Micrologic 2		
29661	Circuit breaker Compact NS100N TMD 80 A 4P 3d and N/2		Replaced by Micrologic 2		
29670	Circuit breaker Compact NS100H TMD 100 A 3P 3d	LV429670	3P3D TM100t NSX100H; Compact circuit breaker		
29671	Circuit breaker Compact NS100H TMD 80 A 3P 3d	LV429671	3P3D TM80t NSX100H; Compact circuit breaker		
29672	Circuit breaker Compact NS100H TMD 63 A 3P 3d	LV429672	3P3D TM63t NSX100H; Compact circuit breaker		
29673	Circuit breaker Compact NS100H TMD 40 A 3P 3d	LV429674	3P3D TM40t NSX100H; Compact circuit breaker		
29674	Circuit breaker Compact NS100H TMD 25 A 3P 3d	LV429676	3P3D TM25t NSX100H; Compact circuit breaker		
29675	Circuit breaker Compact NS100H TMD 16 A 3P 3d	LV429677	3P3D TM16t NSX100H; Compact circuit breaker		
29676	Circuit breaker Compact NS100H TMD 50 A 3P 3d	LV429673	3P3D TM50t NSX100H; Compact circuit breaker		
29677	Circuit breaker Compact NS100H TMD 32 A 3P 3d	LV429675	3P3D TM32t NSX100H; Compact circuit breaker		
29680	Circuit breaker Compact NS100H TMD 100 A 4P 3d	LV429680	4P3D TM100t NSX100H; Compact circuit breaker		
29681	Circuit breaker Compact NS100H TMD 80 A 4P 3d	LV429681	4P3D TM80t NSX100H; Compact circuit breaker		
29682	Circuit breaker Compact NS100H TMD 63 A 4P 3d	LV429682	4P3D TM63t NSX100H; Compact circuit breaker		
29683	Circuit breaker Compact NS100H TMD 40 A 4P 3d	LV429684	4P3D TM40t NSX100H; Compact circuit breaker		
29684	Circuit breaker Compact NS100H TMD 25 A 4P 3d	LV429686	4P3D TM25t NSX100H; Compact circuit breaker		
29685	Circuit breaker Compact NS100H TMD 16 A 4P 3d	LV429687	4P3D TM16t NSX100H; Compact circuit breaker		
29686	Circuit breaker Compact NS100H TMD 50 A 4P 3d	LV429683	4P3D TM50t NSX100H; Compact circuit breaker		
29687	Circuit breaker Compact NS100H TMD 32 A 4P 3d	LV429685	4P3D TM32t NSX100H; Compact circuit breaker		
29690	Circuit breaker Compact NS100H TMD 100 A 4P 4d	LV429690	4P4D TM100t NSX100H; Compact circuit breaker		
29691	Circuit breaker Compact NS100H TMD 80 A 4P 4d	LV429691	4P4D TM80t NSX100H; Compact circuit breaker		
29692	Circuit breaker Compact NS100H TMD 63 A 4P 4d	LV429692	4P4D TM63t NSX100H; Compact circuit breaker		
29693	Circuit breaker Compact NS100H TMD 40 A 4P 4d	LV429694	4P4D TM40t NSX100H; Compact circuit breaker		
29694	Circuit breaker Compact NS100H TMD 25 A 4P 4d	LV429696	4P4D TM25t NSX100H; Compact circuit breaker		
29695	Circuit breaker Compact NS100H TMD 16 A 4P 4d	LV429697	4P4D TM16t NSX100H; Compact circuit breaker		
29696	Circuit breaker Compact NS100H TMD 50 A 4P 4d	LV429693	4P4D TM50t NSX100H; Compact circuit breaker		
29697	Circuit breaker Compact NS100H TMD 32 A 4P 4d	LV429695	4P4D TM32t NSX100H; Compact circuit breaker		
29700	Circuit breaker Compact NS100H TMD 100 A 4P 3d and N/2		Replaced by Micrologic 2		
29701	Circuit breaker Compact NS100H TMD 80 A 4P 3d and N/2		Replaced by Micrologic 2		
29744	NS100N MA50A 3P3D	LV429741	3P3D MA50 NSX100F; Compact circuit breaker		
29745	NS100N MA100A 3P3D	LV429740	3P3D MA100 NSX100F; Compact circuit breaker		
29770	Circuit breaker Compact NS100N STR22SE 100 A 3P 3d	LV429770	3P3D Micrologic 2.2 100A NSX100F; Compact circuit breaker		
29772	Circuit breaker Compact NS100N STR22SE 40 A 3P 3d	LV429772	3P3D Micrologic 2.2 40A NSX100F; Compact circuit breaker		
29780	Circuit breaker Compact NS100N STR22SE 100 A 4P 4d	LV429780	4P4D Micrologic 2.2 100A NSX100F; Compact circuit breaker		
29782	Circuit breaker Compact NS100N STR22SE 40 A 4P 4d	LV429782	4P4D Micrologic 2.2 40A NSX100F; Compact circuit breaker		
29790	Circuit breaker Compact NS100H STR22SE 100 A 3P 3d	LV429790	3P3D Micrologic 2.2 100A NSX100H; Compact circuit breaker		
29792	Circuit breaker Compact NS100H STR22SE 40 A 3P 3d	LV429792	3P3D Micrologic 2.2 40A NSX100H; Compact circuit breaker		
29800	Circuit breaker Compact NS100H STR22SE 100 A 4P 4d	LV429800	4P4D Micrologic 2.2 100A NSX100H; Compact circuit breaker		
29802	Circuit breaker Compact NS100H STR22SE 40 A 4P 4d	LV429802	4P4D Micrologic 2.2 40A NSX100H; Compact circuit breaker		
29810	Circuit breaker Compact NS100L STR22SE 100 A 3P 3d		Order breaker + trip unit		
29812	Circuit breaker Compact NS100L STR22SE 40 A 3P 3d		Order breaker + trip unit		
29820	Circuit breaker Compact NS100L STR22SE 100 A 4P 4d		Order breaker + trip unit		
29822	Circuit breaker Compact NS100L STR22SE 40 A 4P 4d		Order breaker + trip unit		
29930	Circuit breaker Vigicompact NS100N TMD 100 A 3P 3d 30 to 10000 mA	LV429930	3P3D TM100D Vigi MH NSX100F; Vigicompact circuit breaker		
29931	Circuit breaker Vigicompact NS100N TMD 80 A 3P 3d 30 to 10000 mA	LV429931	3P3D TM80D Vigi MH NSX100F; Vigicompact circuit breaker		
29932	Circuit breaker Vigicompact NS100N TMD 63 A 3P 3d 30 to 10000 mA	LV429932	3P3D TM63D Vigi MH NSX100F; Vigicompact circuit breaker		
29933	Circuit breaker Vigicompact NS100N TMD 40 A 3P 3d 30 to 10000 mA	LV429934	3P3D TM40D Vigi MH NSX100F; Vigicompact circuit breaker		

Compact NS Cat. number	Designation	Compact NSX Cat. number	Designation	Compatibility	
				NS/NSX	NSX/NS
29934	Circuit breaker Vigicompact NS100N TMD 25 A 3P 3d 30 to 10000 mA	LV429936	3P3D TM25D Vigi MH NSX100F; Vigicompact circuit breaker		
29935	Circuit breaker Vigicompact NS100N TMD 16 A 3P 3d 30 to 10000 mA	LV429937	3P3D TM16D Vigi MH NSX100F; Vigicompact circuit breaker		
29936	Circuit breaker Vigicompact NS100N TMD 50 A 3P 3d 30 to 10000 mA	LV429933	3P3D TM50D Vigi MH NSX100F; Vigicompact circuit breaker		
29937	Circuit breaker Vigicompact NS100N TMD 32 A 3P 3d 30 to 10000 mA	LV429935	3P3D TM32D Vigi MH NSX100F; Vigicompact circuit breaker		
29940	Circuit breaker Vigicompact NS100N TMD 100 A 4P 3d 30 to 10000 mA	LV429940	4P3D TM100D Vigi MH NSX100F; Vigicompact circuit breaker		
29941	Circuit breaker Vigicompact NS100N TMD 80 A 4P 3d 30 to 10000 mA	LV429941	4P3D TM80D Vigi MH NSX100F; Vigicompact circuit breaker		
29942	Circuit breaker Vigicompact NS100N TMD 63 A 4P 3d 30 to 10000 mA	LV429942	4P3D TM63D Vigi MH NSX100F; Vigicompact circuit breaker		
29943	Circuit breaker Vigicompact NS100N TMD 40 A 4P 3d 30 to 10000 mA	LV429944	4P3D TM40D Vigi MH NSX100F; Vigicompact circuit breaker		
29944	Circuit breaker Vigicompact NS100N TMD 25 A 4P 3d 30 to 10000 mA	LV429946	4P3D TM25D Vigi MH NSX100F; Vigicompact circuit breaker		
29945	Circuit breaker Vigicompact NS100N TMD 16 A 4P 3d 30 to 10000 mA	LV429947	4P3D TM16D Vigi MH NSX100F; Vigicompact circuit breaker		
29946	Circuit breaker Vigicompact NS100N TMD 50 A 4P 3d 30 to 10000 mA	LV429943	4P3D TM50D Vigi MH NSX100F; Vigicompact circuit breaker		
29947	Circuit breaker Vigicompact NS100N TMD 32 A 4P 3d 30 to 10000 mA	LV429945	4P3D TM32D Vigi MH NSX100F; Vigicompact circuit breaker		
29950	Circuit breaker Vigicompact NS100N TMD 100 A 4P 4d 30 to 10000 mA	LV429950	4P4D TM100D Vigi MH NSX100F; Vigicompact circuit breaker		
29951	Circuit breaker Vigicompact NS100N TMD 80 A 4P 4d 30 to 10000 mA	LV429951	4P4D TM80D Vigi MH NSX100F; Vigicompact circuit breaker		
29952	Circuit breaker Vigicompact NS100N TMD 63 A 4P 4d 30 to 10000 mA	LV429952	4P4D TM63D Vigi MH NSX100F; Vigicompact circuit breaker		
29953	Circuit breaker Vigicompact NS100N TMD 40 A 4P 4d 30 to 10000 mA	LV429954	4P4D TM40D Vigi MH NSX100F; Vigicompact circuit breaker		
29954	Circuit breaker Vigicompact NS100N TMD 25 A 4P 4d 30 to 10000 mA	LV429956	4P4D TM25D Vigi MH NSX100F; Vigicompact circuit breaker		
29955	Circuit breaker Vigicompact NS100N TMD 16 A 4P 4d 30 to 10000 mA	LV429957	4P4D TM16D Vigi MH NSX100F; Vigicompact circuit breaker		
29956	Circuit breaker Vigicompact NS100N TMD 50 A 4P 4d 30 to 10000 mA	LV429953	4P4D TM50D Vigi MH NSX100F; Vigicompact circuit breaker		
29957	Circuit breaker Vigicompact NS100N TMD 32 A 4P 4d 30 to 10000 mA	LV429955	4P4D TM32D Vigi MH NSX100F; Vigicompact circuit breaker		
29960	Circuit breaker Vigicompact NS100N TMD 100 A 4P 3d and N/2 30 to 10000 mA		Replaced by Micrologic 2		
29961	Circuit breaker Vigicompact NS100N TMD 80 A 4P 3d and N/2 30 to 10000 mA		Replaced by Micrologic 2		
29970	Circuit breaker Vigicompact NS100N STR22SE 100 A 3P 3d 30 to 10000 mA	LV429970	3P3D Micrologic 2.2 100 A Vigi MH NSX100F; Vigicompact circuit breaker		
29972	Circuit breaker Vigicompact NS100N STR22SE 40 A 3P 3d 30 to 10000 mA	LV429972	3P3D Micrologic 2.2 40 A Vigi MH NSX100F; Vigicompact circuit breaker		
29980	Circuit breaker Vigicompact NS100N STR22SE 100 A 4P 4d 30 to 10000 mA	LV429980	4P4D Micrologic 2.2 100 A Vigi MH NSX100F; Vigicompact circuit breaker		
29982	Circuit breaker Vigicompact NS100N STR22SE 40 A 4P 4d 30 to 10000 mA	LV429982	4P4D Micrologic 2.2 40 A Vigi MH NSX100F; Vigicompact circuit breaker		
30400	NS160N 2P3P without trip unit		Order a complete breaker with trip unit		
30403	Basic frame Compact NS160N 160 A 3P fixed	LV430403	3P NSX160F without trip unit; Compact circuit breaker		
30404	NS160H 3P without trip unit	LV430404	3P NSX160H without trip unit; Compact circuit breaker		
30405	NS160L 3P without trip unit	LV430405	3P NSX160L without trip unit; Compact circuit breaker		
30406	Circuit breaker NS160 SX 3P without trip unit	LV430406	3P NSX160N without trip unit; Compact circuit breaker		
30408	Basic frame Compact NS160N 160 A 4P fixed	LV430408	4P NSX160F without trip unit; Compact circuit breaker		
30409	NS160H 4P without trip unit	LV430409	4P NSX160H without trip unit; Compact circuit breaker		
30410	NS160L 4P without trip unit	LV430410	4P NSX160L without trip unit; Compact circuit breaker		
30411	Circuit breaker NS160 SX 4P without trip unit	LV430411	4P NSX160N without trip unit; Compact circuit breaker		
30420	Trip unit TMD 160 A 3 poles 2d		Order a complete breaker with trip unit	No	
30421	Trip unit TMD 125 A 3 poles 2d		Order a complete breaker with trip unit	No	
30422	Trip unit TMD 100 A 3 poles 2d		Order a complete breaker with trip unit	No	
30423	Trip unit TMD 80 A 3 poles 2d		Order a complete breaker with trip unit	No	
30430	Trip unit TMD 160 A 3 poles 3d	LV430430	3P3D TM160D trip unit; for NSX160/250 circuit breaker	No	
30431	Trip unit TMD 125 A 3 poles 3d	LV430431	3P3D TM125D trip unit; for NSX160/250 circuit breaker	No	
30432	Trip unit TMD 100 A 3 poles 3d	LV429070	3P3D Micrologic 2.2 100 A trip unit; for NSX100-250 circuit breaker	No	
30433	Trip unit TMD 80 A 3 poles 3d	LV429070	3P3D Micrologic 2.2 100 A trip unit; for NSX100-250 circuit breaker	No	
30440	Trip unit TMD 160 A 4 poles 3d	LV430440	4P3D TM160D trip unit; for NSX160/250 circuit breaker	No	
30441	Trip unit TMD 125 A 4 poles 3d	LV430441	4P3D TM125D trip unit; for NSX160/250 circuit breaker	No	
30442	Trip unit TMD 100 A 4 poles 3d	LV429080	4P4D Micrologic 2.2 100 A trip unit; for NSX100-250 circuit breaker	No	
30443	Trip unit TMD 80 A 4 poles 3d	LV429080	4P4D Micrologic 2.2 100 A trip unit; for NSX100-250 circuit breaker	No	

Substitution table

Compatibility of components

Compact NS to NSX

and Compact NSX to NS

Compact NS Cat. number	Designation	Compact NSX Cat. number	Designation	Compatibility	
				NS/NSX	NSX/NS
30450	Trip unit TMD 160 A 4 poles 4d	LV430450	4P4D TM160D trip unit; for NSX160/250 circuit breaker	No	
30451	Trip unit TMD 125 A 4 poles 4d	LV430451	4P4D TM125D trip unit; for NSX160/250 circuit breaker	No	
30452	Trip unit TMD 100 A 4 poles 4d	LV429080	4P4D Micrologic 2.2 100 A trip unit; for NSX100-250 circuit breaker	No	
30453	Trip unit TMD 80 A 4 poles 4d	LV429080	4P4D Micrologic 2.2 100 A trip unit; for NSX100-250 circuit breaker	No	
30456	Non automatic trip unit 3P (NS160/250)		Order a complete switch-disconnector	No	
30457	Non automatic trip unit 4P (NS160/250)		Order a complete switch-disconnector	No	
30460	Trip unit TMD 160 A 4 poles 3d and N/2	LV430480	4P4D Micrologic 2.2 160 A trip unit; for NSX160/250 circuit breaker	No	
30461	Trip unit TMD 125 A 4 poles 3d and N/2	LV430480	4P4D Micrologic 2.2 160 A trip unit; for NSX160/250 circuit breaker	No	
30462	Trip unit TMD 100 A 4 poles 3d and N/2	LV429080	4P4D Micrologic 2.2 100 A trip unit; for NSX100-250 circuit breaker	No	
30463	Trip unit TMD 80 A 4 poles 3d and N/2	LV429080	4P4D Micrologic 2.2 100 A trip unit; for NSX100-250 circuit breaker	No	
30466	Trip unit STR22SE OSN 160 A 4 poles 3d	LV430495	4P4D Micrologic 5.2 160 A trip unit; for NSX100-250 circuit breaker	No	
30470	Trip unit STR22SE 160 A 3 poles 3d	LV430470	3P3D Micrologic 2.2 160 A trip unit; for NSX160/250 circuit breaker	No	
30471	Trip unit STR22SE 80 A 3 poles 3d	LV429070	3P3D Micrologic 2.2 100 A trip unit; for NSX100-250 circuit breaker		
30475	Trip unit STR22GE 160 A 3 poles 3d	LV430475	3P3D Micrologic 2.2 G 160 A trip unit; for NSX160/250 circuit breaker	No	
30480	Trip unit STR22SE 160 A 4 poles 4d	LV430480	4P4D Micrologic 2.2 160 A trip unit; for NSX160/250 circuit breaker	No	
30481	Trip unit STR22SE 80 A 4 poles 4d	LV429080	4P4D Micrologic 2.2 100 A trip unit; for NSX100-250 circuit breaker		
30485	Trip unit STR22GE 160 A 4 poles 4d	LV430485	4P4D Micrologic 2.2 G 160 A trip unit; for NSX160/250 circuit breaker	No	
30500	Trip unit MA 150 A 3 poles 3d	LV430500	3P3D MA150 trip unit; for NSX160/250 circuit breaker	No	
30510	Trip unit MA 150 A 4 poles 3d	LV430510	4P3D MA150 trip unit; for NSX160/250 circuit breaker	No	
30520	Trip unit STR22ME 150 A 3 poles 3d	LV430520	3P3D Micrologic 2.2 M 150 A trip unit; for NSX160/250 circuit breaker	No	
30554	12 clip-on nuts M8 FC (NS100/250)	LV430554	12 snap-in nuts M8 fixed front connect; INV/INS NSX160/250 breaker accessory	Yes	Yes
30555	Ammeter module for NS160 3P 160 A	LV430555	3P 160 A ammeter module; NSX160/250 circuit breaker accessory	No	No
30556	Ammeter module for NS160 4P 160 A	LV430556	4P 160 A ammeter module; INV/INS NSX160/250 circuit breaker accessory	No	No
30557	Current transformer module for NS160 3P 150 A	LV430557	3P 150/5 A current transfo module; NSX160/250 circuit breaker accessory	No	No
30558	Current transformer module for NS160 4P 150 A	LV430558	4P 150/5 A current transfo module; INV/INS NSX160/250 circuit breaker accessory	No	No
30561	CT module 3P 3CT 150A/5 A with voltage outputs	LV430561	3P 150/5 A CT module + voltage outputs; NSX160/250 circuit breaker accessory	No	No
30562	CT module 4P 3CT 150A/5 A with voltage outputs	LV430562	4P 150/5 A CT module + voltage outputs; NSX160/250 circuit breaker accessory	No	No
30619	Molded case switch-disconnector Compact NS160 NA 2P 160 A	LV430619	2P (3P) NSX160NA; Compact switch-disconnector		
30620	Circuit breaker Compact NS160N TMD 160 A 3P 2d	LV430620	3P2D TM160D NSX160F; Compact circuit breaker		
30621	Circuit breaker Compact NS160N TMD 125 A 3P 2d	LV430621	3P2D TM125D NSX160F; Compact circuit breaker		
30622	Circuit breaker Compact NS160N TMD 100 A 3P 2d	LV430622	3P2D TM100D NSX160F; Compact circuit breaker		
30623	Circuit breaker Compact NS160N TMD 80 A 3P 2d	LV430623	3P2D TM80D NSX160F; Compact circuit breaker		
30624	Circuit breaker NS160N TM63D 2P-3P 2T	LV430624	3P2D TM63D NSX160F; Compact circuit breaker		
30625	Circuit breaker NS160N TM40D 2P-3P 2T	LV430625	3P2D TM40D NSX160F; Compact circuit breaker		
30629	Molded case switch-disconnector Compact NS160 NA 3P 160 A	LV430629	3P NSX160NA; Compact switch-disconnector		
30630	Circuit breaker Compact NS160N TMD 160 A 3P 3d	LV430630	3P3D TM160D NSX160F; Compact circuit breaker		
30631	Circuit breaker Compact NS160N TMD 125 A 3P 3d	LV430631	3P3D TM125D NSX160F; Compact circuit breaker		
30632	Circuit breaker Compact NS160N TMD 100 A 3P 3d	LV430632	3P3D TM100D NSX160F; Compact circuit breaker		
30633	Circuit breaker Compact NS160N TMD 80 A 3P 3d	LV430633	3P3D TM80D NSX160F; Compact circuit breaker		
30634	Circuit breaker NS160N TM63D 3P3T	LV430634	3P3D TM63D NSX160F; Compact circuit breaker		
30635	Circuit breaker NS160N TM40D 3P3T	LV430635	3P3D TM40D NSX160F; Compact circuit breaker		
30639	Molded case switch-disconnector Compact NS160 NA 4P 160 A	LV430639	4P NSX160NA; Compact switch-disconnector		
30640	Circuit breaker Compact NS160N TMD 160 A 4P 3d	LV430640	4P3D TM160D NSX160F; Compact circuit breaker		
30641	Circuit breaker Compact NS160N TMD 125 A 4P 3d	LV430641	4P3D TM125D NSX160F; Compact circuit breaker		
30642	Circuit breaker Compact NS160N TMD 100 A 4P 3d	LV430642	4P3D TM100D NSX160F; Compact circuit breaker		
30643	Circuit breaker Compact NS160N TMD 80 A 4P 3d	LV430643	4P3D TM80D NSX160F; Compact circuit breaker		
30644	Circuit breaker NS160N TM63D 4P3T	LV430644	4P3D TM63D NSX160F; Compact circuit breaker		
30645	Circuit breaker NS160N TM40D 4P3T	LV430645	4P3D TM40D NSX160F; Compact circuit breaker		
30650	Circuit breaker Compact NS160N TMD 160 A 4P 4d	LV430650	4P4D TM160D NSX160F; Compact circuit breaker		
30651	Circuit breaker Compact NS160N TMD 125 A 4P 4d	LV430651	4P4D TM125D NSX160F; Compact circuit breaker		
30652	Circuit breaker Compact NS160N TMD 100 A 4P 4d	LV430652	4P4D TM100D NSX160F; Compact circuit breaker		
30653	Circuit breaker Compact NS160N TMD 80 A 4P 4d	LV430653	4P4D TM80D NSX160F; Compact circuit breaker		

Compact NS Cat. number	Designation	Compact NSX Cat. number	Designation	Compatibility	
				NS/NSX	NSX/NS
30654	Circuit breaker NS160N TM63D 4P4T	LV430654	4P4D TM63D NSX160F; Compact circuit breaker		
30655	Circuit breaker NS160N TM40D 4P4T	LV430656	4P4D TM40D NSX160F; Compact circuit breaker		
30660	Circuit breaker Compact NS160N TMD 160 A 4P 3d and N/2		Replaced by Micrologic 2		
30661	Circuit breaker Compact NS160N TMD 125 A 4P 3d and N/2		Replaced by Micrologic 2		
30662	Circuit breaker Compact NS160N TMD 100 A 4P 3d and N/2		Replaced by Micrologic 2		
30663	Circuit breaker Compact NS160N TMD 80 A 4P 3d and N/2		Replaced by Micrologic 2		
30670	Circuit breaker Compact NS160H TMD 160 A 3P 3d	LV430670	3P3D TM160t NSX160H; Compact circuit breaker		
30671	Circuit breaker Compact NS160H TMD 125 A 3P 3d	LV430671	3P3D TM125t NSX160H; Compact circuit breaker		
30672	Circuit breaker Compact NS160H TMD 100 A 3P 3d	LV430672	3P3D TM100t NSX160H; Compact circuit breaker		
30673	Circuit breaker Compact NS160H TMD 80 A 3P 3d	LV430673	3P3D TM80t NSX160H; Compact circuit breaker		
30674	Circuit breaker NS160H TM63D 3P3T	LV430674	3P3D TM63t NSX160H; Compact circuit breaker		
30675	Circuit breaker NS160H TM40D 3P3T	LV430676	3P3D TM40t NSX160H; Compact circuit breaker		
30680	Circuit breaker Compact NS160H TMD 160 A 4P 3d	LV430680	4P3D TM160t NSX160H; Compact circuit breaker		
30681	Circuit breaker Compact NS160H TMD 125 A 4P 3d	LV430681	4P3D TM125t NSX160H; Compact circuit breaker		
30682	Circuit breaker Compact NS160H TMD 100 A 4P 3d	LV430682	4P3D TM100t NSX160H; Compact circuit breaker		
30683	Circuit breaker Compact NS160H TMD 80 A 4P 3d	LV430683	4P3D TM80t NSX160H; Compact circuit breaker		
30684	Circuit breaker NS160H TM63D 4P3T	LV430684	4P3D TM63t NSX160H; Compact circuit breaker		
30685	Circuit breaker NS160H TM40D 4P3T	LV430686	4P3D TM40t NSX160H; Compact circuit breaker		
30690	Circuit breaker Compact NS160H TMD 160 A 4P 4d	LV430690	4P4D TM160t NSX160H; Compact circuit breaker		
30691	Circuit breaker Compact NS160H TMD 125 A 4P 4d	LV430691	4P4D TM125t NSX160H; Compact circuit breaker		
30692	Circuit breaker Compact NS160H TMD 100 A 4P 4d	LV430692	4P4D TM100t NSX160H; Compact circuit breaker		
30693	Circuit breaker Compact NS160H TMD 80 A 4P 4d	LV430693	4P4D TM80t NSX160H; Compact circuit breaker		
30694	Circuit breaker NS160H TM63D 4P4T	LV430694	4P4D TM63t NSX160H; Compact circuit breaker		
30695	Circuit breaker NS160H TM40D 4P4T	LV430696	4P4D TM40t NSX160H; Compact circuit breaker		
30700	Circuit breaker Compact NS160H TMD 160 A 4P 3d and N/2		Replaced by Micrologic 2		
30701	Circuit breaker Compact NS160H TMD 125 A 4P 3d and N/2		Replaced by Micrologic 2		
30702	Circuit breaker Compact NS160H TMD 100 A 4P 3d and N/2		Replaced by Micrologic 2		
30703	Circuit breaker Compact NS160H TMD 80 A 4P 3d and N/2		Replaced by Micrologic 2		
30710	Circuit breaker Compact NS160L TMD 160 A 3P 3d		Order breaker + trip unit		
30711	Circuit breaker Compact NS160L TMD 125 A 3P 3d		Order breaker + trip unit		
30712	Circuit breaker Compact NS160L TMD 100 A 3P 3d		Order breaker + trip unit		
30713	Circuit breaker Compact NS160L TMD 80 A 3P 3d		Order breaker + trip unit		
30714	Circuit breaker NS160L TM63D 3P3T		Order breaker + trip unit		
30715	Circuit breaker NS160L TM40D 3P3T		Order breaker + trip unit		
30720	Circuit breaker Compact NS160L TMD 160 A 4P 3d		Order breaker + trip unit		
30721	Circuit breaker Compact NS160L TMD 125 A 4P 3d		Order breaker + trip unit		
30722	Circuit breaker Compact NS160L TMD 100 A 4P 3d		Order breaker + trip unit		
30723	Circuit breaker Compact NS160L TMD 80 A 4P 3d		Order breaker + trip unit		
30724	Circuit breaker NS160L TM63D 4P3T		Order breaker + trip unit		
30725	Circuit breaker NS160L TM40D 4P3T		Order breaker + trip unit		
30730	Circuit breaker Compact NS160L TMD 160 A 4P 4d		Order breaker + trip unit		
30731	Circuit breaker Compact NS160L TMD 125 A 4P 4d		Order breaker + trip unit		
30732	Circuit breaker Compact NS160L TMD 100 A 4P 4d		Order breaker + trip unit		
30733	Circuit breaker Compact NS160L TMD 80 A 4P 4d		Order breaker + trip unit		
30734	Circuit breaker NS160L TM63D 4P4T		Order breaker + trip unit		
30735	Circuit breaker NS160L TM40D 4P4T		Order breaker + trip unit		
30740	Circuit breaker Compact NS160L TMD 160 A 4P 3d and N/2		Replaced by Micrologic 2		
30741	Circuit breaker Compact NS160L TMD 125 A 4P 3d and N/2		Replaced by Micrologic 2		
30742	Circuit breaker Compact NS160L TMD 100 A 4P 3d and N/2		Replaced by Micrologic 2		
30743	Circuit breaker Compact NS160L TMD 80 A 4P 3d and N/2		Replaced by Micrologic 2		
30744	Circuit breaker NS160N MA150A 3P3D	LV430832	3P3D MA150 NSX160N; Compact circuit breaker		
30770	Circuit breaker Compact NS160N STR22SE 160 A 3P 3d	LV430770	3P3D Micrologic 2.2 160 A NSX160F; Compact circuit breaker		
30771	Circuit breaker Compact NS160N STR22SE 100 A 3P 3d	LV430771	3P3D Micrologic 2.2 100 A NSX160F; Compact circuit breaker		
30773	Circuit breaker Compact NS160N STR22SE 40 A 3P 3d	LV430773	3P3D Micrologic 2.2 40 A NSX160F; Compact circuit breaker		
30780	Circuit breaker Compact NS160N STR22SE 160 A 4P 4d	LV430780	4P4D Micrologic 2.2 160 A NSX160F; Compact circuit breaker		
30781	Circuit breaker Compact NS160N STR22SE 100 A 4P 4d	LV430781	4P4D Micrologic 2.2 100 A NSX160F; Compact circuit breaker		
30783	Circuit breaker Compact NS160N STR22SE 40 A 4P 4d	LV430783	4P4D Micrologic 2.2 40 A NSX160F; Compact circuit breaker		

Substitution table

Compatibility of components

Compact NS to NSX

and Compact NSX to NS

Compact NS Cat. number	Designation	Compact NSX Cat. number	Designation	Compatibility	
				NS/NSX	NSX/NS
30790	Circuit breaker Compact NS160H STR22SE 160 A 3P 3d	LV430790	3P3D Micrologic 2.2 160 A NSX160H; Compact circuit breaker		
30791	Circuit breaker Compact NS160H STR22SE 100 A 3P 3d	LV430791	3P3D Micrologic 2.2 100 A NSX160H; Compact circuit breaker		
30793	Circuit breaker Compact NS160H STR22SE 40 A 3P 3d	LV430793	3P3D Micrologic 2.2 40 A NSX160H; Compact circuit breaker		
30800	Circuit breaker Compact NS160H STR22SE 160 A 4P 4d	LV430800	4P4D Micrologic 2.2 160 A NSX160H; Compact circuit breaker		
30801	Circuit breaker Compact NS160H STR22SE 100 A 4P 4d	LV430801	4P4D Micrologic 2.2 100 A NSX160H; Compact circuit breaker		
30803	Circuit breaker Compact NS160H STR22SE 40 A 4P 4d	LV430803	4P4D Micrologic 2.2 40 A NSX160H; Compact circuit breaker		
30810	Circuit breaker Compact NS160L STR22SE 160 A 3P 3d		Order breaker + trip unit		
30811	Circuit breaker Compact NS160L STR22SE 100 A 3P 3d		Order breaker + trip unit		
30813	Circuit breaker Compact NS160L STR22SE 40 A 3P 3d		Order breaker + trip unit		
30820	Circuit breaker Compact NS160L STR22SE 160 A 4P 4d		Order breaker + trip unit		
30821	Circuit breaker Compact NS160L STR22SE 100 A 4P 4d		Order breaker + trip unit		
30823	Circuit breaker Compact NS160L STR22SE 40 A 4P 4d		Order breaker + trip unit		
30930	Circuit breaker Vigicompact NS160N TMD 160 A 3P 3d 30 to 10000 mA	LV430930	3P3D TM160D Vigi MH NSX160F; Vigicompact circuit breaker		
30931	Circuit breaker Vigicompact NS160N TMD 125 A 3P 3d 30 to 10000 mA	LV430931	3P3D TM125D Vigi MH NSX160F; Vigicompact circuit breaker		
30932	Circuit breaker Vigicompact NS160N TMD 100 A 3P 3d 30 to 10000 mA	LV430932	3P3D TM100D Vigi MH NSX160F; Vigicompact circuit breaker		
30933	Circuit breaker Vigicompact NS160N TMD 80 A 3P 3d 30 to 10000 mA	LV430933	3P3D TM80D Vigi MH NSX160F; Vigicompact circuit breaker		
30934	Vigi MH NS160N TM63D 3P3T	LV430934	3P3D TM63D Vigi MH NSX160F; Vigicompact circuit breaker		
30935	Vigi MH NS160N TM40D 3P3T	LV430936	3P3D TM40D Vigi MH NSX160F; Vigicompact circuit breaker		
30940	Circuit breaker Vigicompact NS160N TMD 160 A 4P 3d 30 to 10000 mA	LV430940	4P3D TM160D Vigi MH NSX160F; Vigicompact circuit breaker		
30941	Circuit breaker Vigicompact NS160N TMD 125 A 4P 3d 30 to 10000 mA	LV430941	4P3D TM125D Vigi MH NSX160F; Vigicompact circuit breaker		
30942	Circuit breaker Vigicompact NS160N TMD 100 A 4P 3d 30 to 10000 mA	LV430942	4P3D TM100D Vigi MH NSX160F; Vigicompact circuit breaker		
30943	Circuit breaker Vigicompact NS160N TMD 80 A 4P 3d 30 to 10000 mA	LV430943	4P3D TM80D Vigi MH NSX160F; Vigicompact circuit breaker		
30944	Vigi MH NS160N TM63D 4P3T	LV430944	4P3D TM63D Vigi MH NSX160F; Vigicompact circuit breaker		
30945	Vigi MH NS160N TM40D 4P3T	LV430946	4P3D TM40D Vigi MH NSX160F; Vigicompact circuit breaker		
30950	Circuit breaker Vigicompact NS160N TMD 160 A 4P 4d 30 to 10000 mA	LV430950	4P4D TM160D Vigi MH NSX160F; Vigicompact circuit breaker		
30951	Circuit breaker Vigicompact NS160N TMD 125 A 4P 4d 30 to 10000 mA	LV430951	4P4D TM125D Vigi MH NSX160F; Vigicompact circuit breaker		
30952	Circuit breaker Vigicompact NS160N TMD 100 A 4P 4d 30 to 10000 mA	LV430952	4P4D TM100D Vigi MH NSX160F; Vigicompact circuit breaker		
30953	Circuit breaker Vigicompact NS160N TMD 80 A 4P 4d 30 to 10000 mA	LV430953	4P4D TM80D Vigi MH NSX160F; Vigicompact circuit breaker		
30954	Vigi MH NS160N TM63D 4P4T	LV430954	4P4D TM63D Vigi MH NSX160F; Vigicompact circuit breaker		
30955	Vigi MH NS160N TM40D 4P4T	LV430956	4P4D TM40D Vigi MH NSX160F; Vigicompact circuit breaker		
30960	Circuit breaker Vigicompact NS160N TMD 160 A 4P 3d and N/2 30 to 10000 mA		Replaced by Micrologic 2		
30961	Circuit breaker Vigicompact NS160N TMD 125 A 4P 3d and N/2 30 to 10000 mA		Replaced by Micrologic 2		
30962	Circuit breaker Vigicompact NS160N TMD 100 A 4P 3d and N/2 30 to 10000 mA		Replaced by Micrologic 2		
30963	Circuit breaker Vigicompact NS160N TMD 80 A 4P 3d and N/2 30 to 10000 mA		Replaced by Micrologic 2		
30970	Circuit breaker Vigicompact NS160N STR22SE 160 A 3P 3d 30 to 10000 mA	LV430970	3P3D Micrologic 2.2 160 A Vigi MH NSX160F; Vigicompact circuit breaker		
30971	Circuit breaker Vigicompact NS160N STR22SE 100 A 3P 3d 30 to 10000 mA	LV430971	3P3D Micrologic 2.2 100 A Vigi MH NSX160F; Vigicompact circuit breaker		
30973	Circuit breaker Vigicompact NS160N STR22SE 40 A 3P 3d 30 to 10000 mA	LV430973	3P3D Micrologic 2.2 40 A Vigi MH NSX160F; Vigicompact circuit breaker		
30980	Circuit breaker Vigicompact NS160N STR22SE 160 A 4P 4d 30 to 10000 mA	LV430980	4P4D Micrologic 2.2 160 A Vigi MH NSX160F; Vigicompact circuit breaker		
30981	Circuit breaker Vigicompact NS160N STR22SE 100 A 4P 4d 30 to 10000 mA	LV430981	4P4D Micrologic 2.2 100 A Vigi MH NSX160F; Vigicompact circuit breaker		
30983	Circuit breaker Vigicompact NS160N STR22SE 40 A 4P 4d 30 to 10000 mA	LV430983	4P4D Micrologic 2.2 40 A Vigi MH NSX160F; Vigicompact circuit breaker		
31060	45 mm pitch one piece spreader for NS100 to 250 3P	LV431060	3P one-piece spreader; NSX100-250 circuit breaker accessory	Yes	Yes
31061	45 mm pitch one piece spreader for NS100 to 250 4P	LV431061	4P one-piece spreader; INV/INS NSX100-250 circuit breaker accessory	Yes	Yes

Compact NS Cat. number	Designation	Compact NSX Cat. number	Designation	Compatibility	
				NS/NSX	NSX/NS
31064	Front alignment base for INV320-630/NS250	LV431064	Front alignment base; INV/INS NSX100-250 circuit breaker accessory	Yes	Yes
31215	Metal enclosure IP55 for NS100/160 and Vigi with STD extended rotary handle	LV431215	Steel enclosure + standard extended rotary handle; NSX100/160 IP55 enclosure	Yes	
31216	Metal enclosure IP55 for NS100/160 and Vigi with Y/R extended rotary handle	LV431216	Steel enclosure + R/Y extended rotary handle; NSX100/160 IP55 enclosure	Yes	
31217	Metal enclosure IP55 for NS250 and Vigi with standard extended rotary handle	LV431217	Steel enclosure + standard extended rotary handle; NSX250/Vigi NSX100-250 IP55 enclosure	Yes	
31218	Metal enclosure IP55 for NS250 and Vigi with Y/R extended rotary handle	LV431218	Steel enclosure + R/Y extended rotary handle; NSX250/Vigi NSX100-250 IP55 enclosure	Yes	
31219	Metal enclosure IP55 for NS400 with standard extended rotary handle	LV431219	Steel enclosure + standard extended rotary handle; NSX400 IP55 enclosure	Yes	
31220	Metal enclosure IP55 for NS400 with Y/R extended rotary handle	LV431220	Steel enclosure + R/Y extended rotary handle; NSX400 IP55 enclosure		
31221	Metal enclosure IP55 for NS630 and Vigi with standard extended rotary handle	LV431221	Steel enclosure + standard extended rotary handle; NSX630/Vigi NSX400/630 IP55 enclosure	Yes	
31222	Metal enclosure IP55 for NS630 and Vigi with Y/R extended rotary handle	LV431222	Steel enclosure + R/Y extended rotary handle; NSX630/Vigi NSX400/630 IP55 enclosure	Yes	
31400	NS250N 2P3P without trip unit		Order breaker + trip unit		
31403	Basic frame Compact NS250N 250 A 3P fixed	LV431403	3P NSX250F without trip unit; Compact circuit breaker		
31404	Basic frame Compact NS250H 250 A 3P fixed	LV431404	3P NSX250H without trip unit; Compact circuit breaker		
31405	NS250L 3P without trip unit	LV431405	3P NSX250L without trip unit; Compact circuit breaker		
31406	Circuit breaker NS250 SX 3P without trip unit	LV431406	3P NSX250N without trip unit; Compact circuit breaker		
31408	Basic frame Compact NS250N 250 A 4P fixed	LV431408	4P NSX250F without trip unit; Compact circuit breaker		
31409	NS250H 4P without trip unit	LV431409	4P NSX250H without trip unit; Compact circuit breaker		
31410	NS250L 4P without trip unit	LV431410	4P NSX250L without trip unit; Compact circuit breaker		
31411	Circuit breaker NS250 SX 4P without trip unit	LV431411	4P NSX250N without trip unit; Compact circuit breaker		
31420	Trip unit TMD 250 A 3 poles 2d		Order a complete breaker with trip unit	No	No
31421	Trip unit TMD 200 A 3 poles 2d		Order a complete breaker with trip unit	No	No
31422	Trip unit TMD 160 A 3 poles 2d		Order a complete breaker with trip unit	No	No
31430	Trip unit TMD 250 A 3 poles 3d	LV431430	3P3D TM250D trip unit; for NSX250 circuit breaker	No	No
31431	Trip unit TMD 200 A 3 poles 3d	LV431431	3P3D TM200D trip unit; for NSX250 circuit breaker	No	No
31432	Trip unit TMD 160 A 3 poles 3d	LV430430	3P3D TM160D trip unit; for NSX250 circuit breaker	No	No
31440	Trip unit TMD 250 A 4 poles 3d	LV431440	4P3D TM250D trip unit; for NSX250 circuit breaker	No	No
31441	Trip unit TMD 200 A 4 poles 3d	LV431441	4P3D TM200D trip unit; for NSX250 circuit breaker	No	No
31442	Trip unit TMD 160 A 4 poles 3d	LV430480	4P3D TM160D trip unit; for NSX250 circuit breaker	No	No
31450	Trip unit TMD 250 A 4 poles 4d	LV431450	4P4D TM250D trip unit; for NSX250 circuit breaker	No	No
31451	Trip unit TMD 200 A 4 poles 4d	LV431451	4P4D TM200D trip unit; for NSX250 circuit breaker	No	No
31452	Trip unit TMD 160 A 4 poles 4d	LV430480	4P4D TM160D trip unit; for NSX250 circuit breaker	No	No
31460	Trip unit TMD 250 A 4 poles 3d and N/2	LV431480	4P4D Micrologic 2.2 250 A trip unit; for NSX250 circuit breaker	No	
31461	Trip unit TMD 200 A 4 poles 3d and N/2	LV431480	4P4D Micrologic 2.2 250 A trip unit; for NSX250 circuit breaker	No	
31462	Trip unit TMD 160 A 4 poles 3d and N/2	LV430480	4P4D Micrologic 2.2 250 A trip unit; for NSX250 circuit breaker	No	
31470	Trip unit STR22SE 250 A 3 poles 3d	LV431470	3P3D Micrologic 2.2 250 A trip unit; for NSX250 circuit breaker	No	No
31475	Trip unit STR22GE 250 A 3 poles 3d	LV431475	3P3D Micrologic 2.2 G 250 A trip unit; for NSX250 circuit breaker	No	No
31480	Trip unit STR22SE 250 A 4 poles 4d	LV431480	4P4D Micrologic 2.2 250 A trip unit; for NSX250 circuit breaker	No	No
31481	Trip unit STR22SE OSN 250 A 4 poles 3d	LV431495	4P4D Micrologic 5.2A 250 A trip unit; for NSX250 circuit breaker	No	
31485	Trip unit STR22GE 250 A 4 poles 4d	LV431485	4P4D Micrologic 2.2 G 250 A trip unit; for NSX250 circuit breaker	No	No
31500	Trip unit MA 220 A 3 poles 3d	LV431500	3P3D MA220 trip unit; for NSX250 circuit breaker	No	No
31510	Trip unit MA 220 A 4 poles 3d	LV431510	4P3D MA220 trip unit; for NSX250 circuit breaker	No	No
31520	Trip unit STR22ME 220 A 3 poles 3d	LV431520	3P3D Micrologic 2.2 M 220 A trip unit; for NSX250 circuit breaker	No	No
31531	Vigi MHM 3P 480/550V (NS250)	LV431531	3P 480-550 V AC 0.03-1 A Vigi MHM; earth-leakage prot. for NSX100-250 breaker	No	
31532	Vigi ME 3P 480/550V (NS250)	LV431532	3P 480-550 V AC 0.25 A Vigi ME; earth-leakage prot. for NSX100-250 breaker	No	
31533	Earthleakage module Compact Vigi MH 3P 440 to 550 V 30 to 10000 mA	LV431533	3P 440-550 V AC 0.03-10 A Vigi MH; earth-leakage prot. for NSX250 breaker	No	No
31534	Earthleakage module Compact Vigi MH 4P 440 to 550 V 30 to 10000 mA	LV431534	4P 440-550 V AC 0.03-10 A Vigi MH; earth-leakage prot. for NSX250 breaker	No	No
31535	Earthleakage module Compact Vigi MH 3P 200 to 440 V 30 to 10000 mA	LV431535	3P 200-440 V AC 0.03-10 A Vigi MH; earth-leakage prot. for NSX250 breaker	No	No
31536	Earthleakage module Compact Vigi MH 4P 200 to 440 V 30 to 10000 mA	LV431536	4P 200-440 V AC 0.03-10 A Vigi MH; earth-leakage prot. for NSX250 breaker	No	No
31540	Motor mechanism Compact MT250 48 to 60 V AC	LV431540	110-130 V AC 50/60 Hz MT250; NSX250 circuit breaker motor Mech. module	No	Yes
31541	Motor mechanism Compact MT250 220 to 240 V AC	LV431541	220-240 V 50/60 Hz 208-277 V 60 Hz MT250; NSX250 breaker motor Mech. module	No	Yes
31542	Motor mechanism Compact MT250 380 to 415 V AC	LV431542	380-415 V 50/60 Hz 440-480 V 60 Hz MT250; NSX250 breaker motor Mech. module	No	Yes
31543	Motor mechanism Compact MT250 24 to 30 V DC	LV431543	24-30 V DC MT250; NSX250 circuit breaker motor mech. module	No	Yes

Substitution table

Compatibility of components

Compact NS to NSX

and Compact NSX to NS

Compact NS Cat. number	Designation	Compact NSX Cat. number	Designation	Compatibility	
				NS/NSX	NSX/NS
31544	Motor mechanism Compact MT250 48 to 60 V DC	LV431544	48-60 V DC MT250; NSX250 circuit breaker motor mech. module	No	Yes
31545	Motor mechanism Compact MT250 110 to 130 V DC	LV431545	110-130 V DC MT250; NSX250 circuit breaker motor mech. module	No	Yes
31546	Motor mechanism Compact MT250 250 V DC	LV431546	250 V DC MT250; NSX250 circuit breaker motor mech. module	No	Yes
31548	Motor mechanism Compact MT250 48 to 60 V AC	LV431548	48-60 V AC 50/60 Hz MT250; NSX250 circuit breaker motor Mech. module	No	Yes
31549	Motor mechanism Compact MT250 220 to 240 V AC	LV431549	Communicating 220-240 V 50/60 Hz MT250; NSX250 breaker motor Mech. module	No	No
31563	45 mm pitch spreader set flat connection for NS100 to 250 3P	LV431563	3P spreader + ph barriers; INS/INV NSX100-250 circuit breaker accessory	Yes	Yes
31564	45 mm pitch spreader set flat connection for NS100 to 250 4P	LV431564	4P spreader + ph barriers; INS/INV NSX100-250 circuit breaker accessory	Yes	Yes
31565	Ammeter module for NS250 3P 250 A	LV431565	3P 250 A ammeter module; NSX250 circuit breaker accessory	No	No
31566	Ammeter module for NS250 4P 250 A	LV431566	4P 250 A ammeter module; NSX250 circuit breaker accessory	No	No
31567	Current transformer module for NS250 3P 250 A	LV431567	3P 250/5 A current transfo module; NSX250 circuit breaker accessory	No	No
31568	Current transformer module for NS250 4P 250 A	LV431568	4P 250/5 A current transfo module; INV/INS NSX250 circuit breaker accessory	No	No
31569	CT module 3P 3CT 250A/5A with voltage outputs	LV431569	3P 250/5 A CT module + voltage outputs; NSX250 circuit breaker accessory	No	No
31570	CT module 4P 3CT 250A/5A with voltage outputs	LV431570	4P 250/5 A CT module + voltage outputs; INV/INS NSX250 circuit breaker accessory	No	No
31573	Weatherproof enclosure for Compact NS250 plastic	LV431573	Insulating enclosure + standard extended rotary handle; NSX250 IP55 enclosure	Yes	
31574	Weatherproof enclosure for Vigicompact NS250 plastic	LV431574	Insulating enclosure + standard extended rotary handle; Vigi NSX250 IP55 enclosure	Yes	
31620	Circuit breaker Compact NS250N TMD 250 A 3P 2d	LV431620	3P2D TM250D NSX250F; Compact circuit breaker		
31621	Circuit breaker Compact NS250N TMD 200 A 3P 2d	LV431621	3P2D TM200D NSX250F; Compact circuit breaker		
31622	Circuit breaker Compact NS250N TMD 160 A 3P 2d	LV431622	3P2D TM160D NSX250F; Compact circuit breaker		
31623	Circuit breaker Compact NS250N TMD 125 A 3P 2d	LV431623	3P2D TM125D NSX250F; Compact circuit breaker		
31624	Circuit breaker NS250N TM100D 2P-3P 2T		Order a complete breaker with trip unit		
31626	Circuit breaker NS250N TM63D 2P-3P 2T		Order a complete breaker with trip unit		
31629	Molded case switch-disconnector Compact NS250 NA 3P 250 A	LV431629	3P NSX250NA; Compact switch-disconnector		
31630	Circuit breaker Compact NS250N TMD 250 A 3P 3d	LV431630	3P3D TM250D NSX250F; Compact circuit breaker		
31631	Circuit breaker Compact NS250N TMD 200 A 3P 3d	LV431631	3P3D TM200D NSX250F; Compact circuit breaker		
31632	Circuit breaker Compact NS250N TMD 160 A 3P 3d	LV431632	3P3D TM160D NSX250F; Compact circuit breaker		
31633	Circuit breaker Compact NS250N TMD 125 A 3P 3d	LV431633	3P3D TM125D NSX250F; Compact circuit breaker		
31634	Circuit breaker NS250N TM100D 3P3T	LV431634	3P3D TM100D NSX250F; Compact circuit breaker		
31635	Circuit breaker NS250N TM80D 3P3T	LV431635	3P3D TM80D NSX250F; Compact circuit breaker		
31636	Circuit breaker NS250N TM63D 3P3T	LV431636	3P3D TM63D NSX250F; Compact circuit breaker		
31637	Circuit breaker NS250N TM40D 3P3T	LV431638	3P3D TM40D NSX250F; Compact circuit breaker		
31639	Molded case switch-disconnector Compact NS250 NA 4P 250 A	LV431639	4P NSX250NA; Compact switch-disconnector		
31640	Circuit breaker Compact NS250N TMD 250 A 4P 3d	LV431640	4P3D TM250D NSX250F; Compact circuit breaker		
31641	Circuit breaker Compact NS250N TMD 200 A 4P 3d	LV431641	4P3D TM200D NSX250F; Compact circuit breaker		
31642	Circuit breaker Compact NS250N TMD 160 A 4P 3d	LV431642	4P3D TM160D NSX250F; Compact circuit breaker		
31643	Circuit breaker Compact NS250N TMD 125 A 4P 3d	LV431643	4P3D TM125D NSX250F; Compact circuit breaker		
31644	Circuit breaker NS250N TM100D 4P3T	LV431644	4P3D TM100D NSX250F; Compact circuit breaker		
31645	Circuit breaker NS250N TM80D 4P3T	LV431645	4P3D TM80D NSX250F; Compact circuit breaker		
31646	Circuit breaker NS250N TM63D 4P3T	LV431646	4P3D TM63D NSX250F; Compact circuit breaker		
31647	Circuit breaker NS250N TM40D 4P3T	LV431648	4P3D TM40D NSX250F; Compact circuit breaker		
31650	Circuit breaker Compact NS250N TMD 250 A 4P 4d	LV431650	4P4D TM250D NSX250F; Compact circuit breaker		
31651	Circuit breaker Compact NS250N TMD 200 A 4P 4d	LV431651	4P4D TM200D NSX250F; Compact circuit breaker		
31652	Circuit breaker Compact NS250N TMD 160 A 4P 4d	LV431652	4P4D TM160D NSX250F; Compact circuit breaker		
31653	Circuit breaker Compact NS250N TMD 125 A 4P 4d	LV431653	4P4D TM125D NSX250F; Compact circuit breaker		
31654	Circuit breaker NS250N TM100D 4P4T	LV431654	4P4D TM100D NSX250F; Compact circuit breaker		
31655	Circuit breaker NS250N TM80D 4P4T	LV431655	4P4D TM80D NSX250F; Compact circuit breaker		
31656	Circuit breaker NS250N TM63D 4P4T	LV431656	4P4D TM63D NSX250F; Compact circuit breaker		
31657	Circuit breaker NS250N TM40D 4P4T	LV431658	4P4D TM40D NSX250F; Compact circuit breaker		
31660	Circuit breaker Compact NS250N TMD 250 A 4P 3d and N/2	LV431780	4P4D Micrologic 2.2 250 A NSX250F; Compact circuit breaker		
31661	Circuit breaker Compact NS250N TMD 200 A 4P 3d and N/2	LV431780	4P4D Micrologic 2.2 250 A NSX250F; Compact circuit breaker		
31662	Circuit breaker Compact NS250N TMD 160 A 4P 3d and N/2	LV430780	4P4D Micrologic 2.2 160 A NSX160F; Compact circuit breaker		
31663	Circuit breaker Compact NS250N TMD 125 A 4P 3d and N/2	LV430780	4P4D Micrologic 2.2 160 A NSX160F; Compact circuit breaker		
31670	Circuit breaker Compact NS250H TMD 250 A 3P 3d	LV431670	3P3D TM250t NSX250H; Compact circuit breaker		
31671	Circuit breaker Compact NS250H TMD 200 A 3P 3d	LV431671	3P3D TM200t NSX250H; Compact circuit breaker		
31672	Circuit breaker Compact NS250H TMD 160 A 3P 3d	LV431672	3P3D TM160t NSX250H; Compact circuit breaker		
31673	Circuit breaker Compact NS250H TMD 125 A 3P 3d	LV431673	3P3D TM125t NSX250H; Compact circuit breaker		
31674	Circuit breaker NS250H TM100D 3P3T	LV431674	3P3D TM100t NSX250H; Compact circuit breaker		

Compact NS Cat. number	Designation	Compact NSX Cat. number	Designation	Compatibility	
				NS/NSX	NSX/NS
31675	Circuit breaker NS250H TM80D 3P3T	LV431675	3P3D TM80t NSX250H; Compact circuit breaker		
31676	Circuit breaker NS250H TM63D 3P3T	LV431676	3P3D TM63t NSX250H; Compact circuit breaker		
31677	Circuit breaker NS250H TM40D 3P3T	LV431678	3P3D TM40t NSX250H; Compact circuit breaker		
31680	Circuit breaker Compact NS250H TMD 250 A 4P 3d	LV431680	4P3D TM250t NSX250H; Compact circuit breaker		
31681	Circuit breaker Compact NS250H TMD 200 A 4P 3d	LV431681	4P3D TM200t NSX250H; Compact circuit breaker		
31682	Circuit breaker Compact NS250H TMD 160 A 4P 3d	LV431682	4P3D TM160t NSX250H; Compact circuit breaker		
31683	Circuit breaker Compact NS250H TMD 125 A 4P 3d	LV431683	4P3D TM125t NSX250H; Compact circuit breaker		
31684	Circuit breaker NS250H TM100D 4P3T	LV431684	4P3D TM100t NSX250H; Compact circuit breaker		
31685	Circuit breaker NS250H TM80D 4P3T	LV431685	4P3D TM80t NSX250H; Compact circuit breaker		
31686	Circuit breaker NS250H TM63D 4P3T	LV431686	4P3D TM63t NSX250H; Compact circuit breaker		
31687	Circuit breaker NS250H TM40D 4P3T	LV431688	4P3D TM40t NSX250H; Compact circuit breaker		
31690	Circuit breaker Compact NS250H TMD 250 A 4P 4d	LV431690	4P4D TM250t NSX250H; Compact circuit breaker		
31691	Circuit breaker Compact NS250H TMD 200 A 4P 4d	LV431691	4P4D TM200t NSX250H; Compact circuit breaker		
31692	Circuit breaker Compact NS250H TMD 160 A 4P 4d	LV431692	4P4D TM160t NSX250H; Compact circuit breaker		
31693	Circuit breaker Compact NS250H TMD 125 A 4P 4d	LV431693	4P4D TM125t NSX250H; Compact circuit breaker		
31694	Circuit breaker NS250H TM100D 4P4T	LV431694	4P4D TM100t NSX250H; Compact circuit breaker		
31695	Circuit breaker NS250H TM80D 4P4T	LV431695	4P4D TM80t NSX250H; Compact circuit breaker		
31697	Circuit breaker NS250H TM40D 4P4T	LV431698	4P4D TM40t NSX250H; Compact circuit breaker		
31700	Circuit breaker Compact NS250H TMD 250 A 4P 3d and N/2		Replaced by Micrologic 2		
31701	Circuit breaker Compact NS250H TMD 200 A 4P 3d and N/2		Replaced by Micrologic 2		
31702	Circuit breaker Compact NS250H TMD 160 A 4P 3d and N/2		Replaced by Micrologic 2		
31703	Circuit breaker Compact NS250H TMD 125 A 4P 3d and N/2		Replaced by Micrologic 2		
31710	Circuit breaker Compact NS250L TMD 250 A 3P 3d		Order breaker + trip unit		
31711	Circuit breaker Compact NS250L TMD 200 A 3P 3d		Order breaker + trip unit		
31712	Circuit breaker Compact NS250L TMD 160 A 3P 3d		Order breaker + trip unit		
31713	Circuit breaker Compact NS250L TMD 125 A 3P 3d		Order breaker + trip unit		
31714	Circuit breaker NS250L TM100D 3P3T		Order breaker + trip unit		
31717	Circuit breaker NS250L TM40D 3P3T		Order breaker + trip unit		
31720	Circuit breaker Compact NS250L TMD 250 A 4P 3d		Order breaker + trip unit		
31721	Circuit breaker Compact NS250L TMD 200 A 4P 3d		Order breaker + trip unit		
31722	Circuit breaker Compact NS250L TMD 160 A 4P 3d		Order breaker + trip unit		
31723	Circuit breaker Compact NS250L TMD 125 A 4P 3d		Order breaker + trip unit		
31730	Circuit breaker Compact NS250L TMD 250 A 4P 4d		Order breaker + trip unit		
31731	Circuit breaker Compact NS250L TMD 200 A 4P 4d		Order breaker + trip unit		
31734	Circuit breaker NS250L TM100D 4P4T		Order breaker + trip unit		
31735	Circuit breaker NS250L TM80D 4P4T		Order breaker + trip unit		
31740	Circuit breaker Compact NS250L TMD 250 A 4P 3d and N/2		Replaced by Micrologic 2		
31741	Circuit breaker Compact NS250L TMD 200 A 4P 3d and N/2		Replaced by Micrologic 2		
31742	Circuit breaker Compact NS250L TMD 160 A 4P 3d and N/2		Replaced by Micrologic 2		
31743	Circuit breaker Compact NS250L TMD 125 A 4P 3d and N/2		Replaced by Micrologic 2		
31744	Circuit breaker NS250L TM100D 4P3T and N/2		Replaced by Micrologic 2		
31746	Circuit breaker NS250N MA220A 3P3D	LV431753	3P3D MA150 NSX250N; Compact circuit breaker		
31770	Circuit breaker Compact NS250N STR22SE 250 A 3P 3d	LV431770	3P3D Micrologic 2.2 250 A NSX250F; Compact circuit breaker		
31772	Circuit breaker Compact NS250N STR22SE 100 A 3P 3d	LV431772	3P3D Micrologic 2.2 100 A NSX250F; Compact circuit breaker		
31774	Circuit breaker NS250N STR22SE 40 3P3T	LV431774	3P3D Micrologic 2.2 40 A NSX250F; Compact circuit breaker		
31780	Circuit breaker Compact NS250N STR22SE 250 A 4P 4d	LV431780	4P4D Micrologic 2.2 250 A NSX250F; Compact circuit breaker		
31782	Circuit breaker Compact NS250N STR22SE 100 A 4P 4d	LV431782	4P4D Micrologic 2.2 100 A NSX250F; Compact circuit breaker		
31784	Circuit breaker NS250N STR22SE 40 4P4T	LV431784	4P4D Micrologic 2.2 40 A NSX250F; Compact circuit breaker		
31790	Circuit breaker Compact NS250H STR22SE 250 A 3P 3d	LV431790	3P3D Micrologic 2.2 250 A NSX250H; Compact circuit breaker		
31792	Circuit breaker Compact NS250H STR22SE 100 A 3P 3d	LV431792	3P3D Micrologic 2.2 100 A NSX250H; Compact circuit breaker		
31794	Circuit breaker NS250H STR22SE 40 3P3T	LV431794	3P3D Micrologic 2.2 40 A NSX250H; Compact circuit breaker		
31800	Circuit breaker Compact NS250H STR22SE 250 A 4P 4d	LV431800	4P4D Micrologic 2.2 250 A NSX250H; Compact circuit breaker		
31802	Circuit breaker Compact NS250H STR22SE 100 A 4P 4d	LV431802	4P4D Micrologic 2.2 100 A NSX250H; Compact circuit breaker		
31810	Circuit breaker Compact NS250L STR22SE 250 A 3P 3d		Order breaker + trip unit		
31812	Circuit breaker Compact NS250L STR22SE 100 A 3P 3d		Order breaker + trip unit		
31814	Circuit breaker NS250L STR22SE 40 3P3T		Order breaker + trip unit		

Substitution table

Compatibility of components

Compact NS to NSX

and Compact NSX to NS

Compact NS Cat. number	Designation	Compact NSX Cat. number	Designation	Compatibility	
				NS/NSX	NSX/NS
31820	Circuit breaker Compact NS250L STR22SE 250 A 4P 4d		Order breaker + trip unit		
31930	Circuit breaker Vigicompact NS250N TMD 250 A 3P 3d 30 to 10000 mA	LV431930	3P3D TM250D Vigi MH NSX250F; Vigicompact circuit breaker		
31931	Circuit breaker Vigicompact NS250N TMD 200 A 3P 3d 30 to 10000 mA	LV431931	3P3D TM200D Vigi MH NSX250F; Vigicompact circuit breaker		
31932	Circuit breaker Vigicompact NS250N TMD 160 A 3P 3d 30 to 10000 mA	LV431932	3P3D TM160D Vigi MH NSX250F; Vigicompact circuit breaker		
31933	Circuit breaker Vigicompact NS250N TMD 125 A 3P 3d 30 to 10000 mA	LV431933	3P3D TM125D Vigi MH NSX250F; Vigicompact circuit breaker		
31940	Circuit breaker Vigicompact NS250N TMD 250 A 4P 3d 30 to 10000 mA	LV431940	4P3D TM250D Vigi MH NSX250F; Vigicompact circuit breaker		
31941	Circuit breaker Vigicompact NS250N TMD 200 A 4P 3d 30 to 10000 mA	LV431941	4P3D TM200D Vigi MH NSX250F; Vigicompact circuit breaker		
31942	Circuit breaker Vigicompact NS250N TMD 160 A 4P 3d 30 to 10000 mA	LV431942	4P3D TM160D Vigi MH NSX250F; Vigicompact circuit breaker		
31943	Circuit breaker Vigicompact NS250N TMD 125 A 4P 3d 30 to 10000 mA	LV431943	4P3D TM125D Vigi MH NSX250F; Vigicompact circuit breaker		
31944	Vigi MH NS250N TM100D 4P3d	LV431944	4P3D TM100D Vigi MH NSX250F; Vigicompact circuit breaker		
31946	Vigi MH NS250N TM63D 4P3d	LV431946	4P3D TM63D Vigi MH NSX250F; Vigicompact circuit breaker		
31950	Circuit breaker Vigicompact NS250N TMD 250 A 4P 4d 30 to 10000 mA	LV431950	4P4D TM250D Vigi MH NSX250F; Vigicompact circuit breaker		
31951	Circuit breaker Vigicompact NS250N TMD 200 A 4P 4d 30 to 10000 mA	LV431951	4P4D TM200D Vigi MH NSX250F; Vigicompact circuit breaker		
31952	Circuit breaker Vigicompact NS250N TMD 160 A 4P 4d 30 to 10000 mA	LV431952	4P4D TM160D Vigi MH NSX250F; Vigicompact circuit breaker		
31953	Circuit breaker Vigicompact NS250N TMD 125 A 4P 4d 30 to 10000 mA	LV431953	4P4D TM125D Vigi MH NSX250F; Vigicompact circuit breaker		
31954	Vigi MH NS250N TM100D 4P4d	LV431954	4P4D TM100D Vigi MH NSX250F; Vigicompact circuit breaker		
31955	Vigi MH NS250N TM80D 4P4d	LV431955	4P4D TM80D Vigi MH NSX250F; Vigicompact circuit breaker		
31956	Vigi MH NS250N TM63D 4P4d	LV431956	4P4D TM63D Vigi MH NSX250F; Vigicompact circuit breaker		
31960	Circuit breaker Vigicompact NS250N TMD 250 A 4P 3d and N/2 30 to 10000 mA		Replaced by Micrologic 2		
31961	Circuit breaker Vigicompact NS250N TMD 200 A 4P 3d and N/2 30 to 10000 mA		Replaced by Micrologic 2		
31962	Circuit breaker Vigicompact NS250N TMD 160 A 4P 3d and N/2 30 to 10000 mA		Replaced by Micrologic 2		
31963	Circuit breaker Vigicompact NS250N TMD 125 A 4P 3d and N/2 30 to 10000 mA		Replaced by Micrologic 2		
31970	Circuit breaker Vigicompact NS250N STR22SE 250 A 3P 3d 30 to 10000 mA	LV431970	3P3D Micrologic 2.2 250 A Vigi MH NSX250F; Vigicompact circuit breaker		
31972	Circuit breaker Vigicompact NS250N STR22SE 100 A 3P 3d 30 to 10000 mA	LV431972	3P3D Micrologic 2.2 100 A Vigi MH NSX250F; Vigicompact circuit breaker		
31980	Circuit breaker Vigicompact NS250N STR22SE 250 A 4P 4d 30 to 10000 mA	LV431980	4P4D Micrologic 2.2 250 A Vigi MH NSX250F; Vigicompact circuit breaker		
31982	Circuit breaker Vigicompact NS250N STR22SE 100 A 4P 4d 30 to 10000 mA	LV431982	4P4D Micrologic 2.2 100 A Vigi MH NSX250F; Vigicompact circuit breaker		
31984	Vigi MH NS250N STR22SE 40 4P4d	LV431984	4P4D Micrologic 2.2 40 A Vigi MH NSX250F; Vigicompact circuit breaker		
32382	Basic frame Compact NS400N 150 A 3P fixed				
32383	Basic frame Compact NS400H 150 A 3P fixed				
32384	Basic frame Compact NS400L 150 A 3P fixed				
32387	Basic frame Compact NS400N 150 A 4P fixed				
32388	Basic frame Compact NS400H 150 A 4P fixed				
32389	Basic frame Compact NS400L 150 A 4P fixed				
32392	Basic frame Compact NS400N 250 A 3P fixed				
32393	Basic frame Compact NS400H 250 A 3P fixed				
32394	Basic frame Compact NS400L 250 A 3P fixed				
32395	NS400N 3PSD 1000 V CAL 250 A				
32397	Basic frame Compact NS400N 250 A 4P fixed				
32398	Basic frame Compact NS400H 250 A 4P fixed				
32399	Basic frame Compact NS400L 250 A 4P fixed				
32401	STR13MAE trip unit		Replaced by Micrologic	No	
32403	Basic frame Compact NS400N 400 A 3P fixed	LV432403	3P NSX400N without trip unit; Compact circuit breaker		
32404	Basic frame Compact NS400H 400 A 3P fixed	LV432404	3P NSX400H without trip unit; Compact circuit breaker		
32405	Basic frame Compact NS400L 400 A 3P fixed	LV432405	3P NSX400L without trip unit; Compact circuit breaker		
32408	Basic frame Compact NS400N 400 A 4P fixed	LV432408	4P NSX400N without trip unit; Compact circuit breaker		
32409	Basic frame Compact NS400H 400 A 4P fixed	LV432409	4P NSX400H without trip unit; Compact circuit breaker		
32410	Basic frame Compact NS400L 400 A 4P fixed	LV432410	4P NSX400L without trip unit; Compact circuit breaker		
32420	Trip unit STR23SE 4 poles 4d		Replaced by Micrologic	No	
32424	Trip unit STR53UE F 4 poles 4d		Replaced by Micrologic	No	
32425	Trip unit STR53UE FT 4 poles 4d		Replaced by Micrologic	No	
32426	Trip unit STR53UE FI 4 poles 4d		Replaced by Micrologic	No	
32427	Trip unit STR53UE FTI 4 poles 4d		Replaced by Micrologic	No	
32429	Trip unit STR53UE FTI 4 poles 4d		Replaced by Micrologic	No	

Compact NS Cat. number	Designation	Compact NSX Cat. number	Designation	Compatibility	
				NS/NSX	NSX/NS
32430	Trip unit STR43ME F 3 poles 3d		Replaced by Micrologic	No	
32431	Trip unit STR43ME FI 3 poles 3d		Replaced by Micrologic	No	
32432	Trip unit STR23SV 4 poles 4d		Replaced by Micrologic	No	
32433	Trip unit STR53SV F 4 poles 4d		Replaced by Micrologic	No	
32440	CT ground fault protection 630 A for NS400 to 630		Replaced by Micrologic	No	
32441	Option COM for STR53 (NS400/630)		Replaced by Micrologic	No	
32442	Option ZSI for STR53 (NS400/630)		Replaced by Micrologic	No	
32443	Trip unit STR23SE OSN 4 poles 3d		Replaced by Micrologic	No	
32453	Earthleakage module Compact Vigi MB 3P 440 to 550 V 300 to 30000 mA	LV432453	3P 440-550 V AC 0.3-30 A Vigi MB; earth-leakage prot for NSX400/630 circuit breaker	No	No
32454	Earthleakage module Compact Vigi MB 4P 440 to 550 V 300 to 30000 mA	LV432454	4P 440-550 V AC 0.3-30 A Vigi MB; earth-leakage prot for NSX400/630 circuit breaker	No	No
32455	Earthleakage module Compact Vigi MB 3P 200 to 440 V 300 to 30000 mA	LV432455	3P 200-240 V AC 0.3-30 A Vigi MB; earth-leakage prot for NSX400/630 circuit breaker	No	No
32456	Earthleakage module Compact Vigi MB 4P 200 to 440 V 300 to 30000 mA	LV432456	4P 200-240 V AC 0.3-30 A Vigi MB; earth-leakage prot for NSX400/630 circuit breaker	No	No
32457	Adaptation Vigi 4P on 3P device (NS400/630)	LV432457	Connection for 4P Vigi on 3P device; 3P NSX400/630 circuit breaker accessory		
32475	Rear connection short for NS400 to 630	LV432475	2 short rear connections; INV/INS NSX400/630 circuit breaker accessory	Yes	Yes
32476	Rear connection long for NS400 to 630	LV432476	2 long rear connections; INV/INS NSX400/630 circuit breaker accessory	Yes	Yes
32477	Rear connection 4 short and 2 long for NS400 to 630 3P		Different packaging	Yes	
32478	Rear connection 4 short and 4 long for NS400 to 630 4P		Different packaging	Yes	
32479	3 connect. 1 cable 35/300 mm ² and 2 ph. sep (NS400/630)	LV432479	3 connectors (1 x 35-300 mm ²) + ph barriers; INV/INS NSX400/630 breaker accessory	Yes	Yes
32480	4 connect. 1 cable 35/300 mm ² and 3 ph. sep (NS400/630)	LV432480	4 1 x 35-300 mm ² connectors + ph barriers; INV/INS NSX400/630 breaker accessory	Yes	Yes
32481	3 connect. 2 cables 35/240 mm ² and 2 ph. sep (NS400/630)	LV432481	3 (2 x 35-240 mm ²) connectors + ph barriers; INV/INS NSX400/630 breaker accessory	Yes	Yes
32482	4 connect. 2 cables 35/240 mm ² and 3 ph. sep. (NS400/630)	LV432482	4 (2 x 35-240 mm ²) connectors + ph barriers; INV/INS NSX400/630 breaker accessory	Yes	Yes
32484	Terminal extension rightangle connection for NS400 to 630 3P	LV432484	3 right angle terminal ext + ph barriers; INV/INS NSX400/630 breaker accessory	Yes	Yes
32485	Terminal extension rightangle connection for NS400 to 630 4P	LV432485	4 right angle terminal ext + ph barriers; INV/INS NSX400/630 breaker accessory	Yes	Yes
32486	Terminal extension edgewise connection for NS400 to 630 3P	LV432486	3 edgewise terminal ext + ph barriers; INV/INS NSX400/630 breaker accessory	Yes	Yes
32487	Terminal extension edgewise connection for NS400 to 630 4P	LV432487	4 edgewise terminal ext + ph barriers; INV/INS NSX400/630 breaker accessory	Yes	Yes
32490	52.5 mm pitch spreader set flat connection for NS400 to 630 3P	LV432490	3P Spreader (52.5 mm) + ph barriers; INV/INS NSX400/630 breaker accessory	Yes	Yes
32491	52.5 mm pitch spreader set flat connection for NS400 to 630 4P	LV432491	4P Spreader (52.5 mm) + ph barriers; INV/INS NSX400/630 breaker accessory	Yes	Yes
32492	70 mm pitch spreader set flat connection for NS400 to 630 3P	LV432492	3P Spreader (70 mm) + ph barriers; INV/INS NSX400/630 breaker accessory	Yes	Yes
32493	70 mm pitch spreader set flat connection for NS400 to 630 4P	LV432493	4P Spreader (70 mm) + ph barriers; INV/INS NSX400/630 breaker accessory	Yes	Yes
32500	3 tubular lugs for copper cable 240 mm ² and 2 sep (NS400/630)	LV432500	3 Cu 240 mm ² crimp lugs + ph barriers; INV/INS NSX400/630 circuit accessory	Yes	Yes
32501	4 tubular lugs for copper cable 240 mm ² and 3 sep (NS400/630)	LV432501	4 Cu 240 mm ² crimp lugs + ph barriers; INV/INS NSX400/630 circuit accessory	Yes	Yes
32502	3 tubular lugs for copper cable 300 mm ² and 2 sep (NS400/630)	LV432502	3 Cu 300 mm ² crimp lugs + ph barriers; INV/INS NSX400/630 circuit accessory	Yes	Yes
32503	4 tubular lugs for copper cable 300 mm ² and 3 sep (NS400/630)	LV432503	4 Cu 300 mm ² crimp lugs + ph barriers; INV/INS NSX400/630 circuit accessory	Yes	Yes
32504	3 bimetallic lugs for alu cable 240 mm ² and 2 sep (NS400/630)	LV432504	3 Al 240 mm ² crimp lugs + ph barriers; INV/INS NSX400/630 breaker accessory	Yes	Yes
32505	4 bimetallic lugs for alu cable 185 mm ² and 3 sep (NS400/630)	LV432505	4 Al 240 mm ² crimp lugs + ph barriers; INV/INS NSX400/630 breaker accessory	Yes	Yes
32506	3 bimetallic lugs for alu cable 300 mm ² and 2 sep (NS400/630)	LV432506	3 Al 300 mm ² crimp lugs + ph barriers; INV/INS NSX400/630 breaker accessory	Yes	Yes
32507	4 bimetallic lugs for alu cable 300 mm ² and 3 sep (NS400/630)	LV432507	4 Al 300 mm ² crimp lugs + ph barriers; INV/INS NSX400/630 breaker accessory	Yes	Yes
32516	Plug-in base F/R connected 3P (NS400/630)	LV432516	3P plug-in base; NSX400/630 circuit breaker accessory	No	Yes
32517	Plug-in base F/R connected 4P (NS400/630)	LV432517	4P plug-in base; NSX400/630 circuit breaker accessory	No	Yes
32518	Stud for drawout installation set of 2 for NS400 to 630	LV432518	2 plug-in base power connections; NSX400/630 circuit breaker accessory		
32519	Stud for drawout installation set of 2 for Vigi NS400 to 630	LV432519	2 Vigi plug-in base power connections; NSX400/630 circuit breaker accessory		
32520	Trip interlock link (NS400/630)	LV432520	Safety trip for advanced opening; NSX400/630 circuit breaker accessory	No	No
32521	2 shutters IP40 for plug-in base (NS400/630)	LV432521	2 IP40 shutters for plug-in base; NSX400/630 circuit breaker accessory		
32523	Moving 9 cable connection block (NS400/630)	LV432523	1 x 9-wire moving connector for breaker; NSX400/630 circuit breaker accessory	Yes	Yes

Substitution table

Compatibility of components

Compact NS to NSX

and Compact NSX to NS

Compact NS Cat. number	Designation	Compact NSX Cat. number	Designation	Compatibility	
				NS/NSX	NSX/NS
32525	Support for moving cable block (NS400/630)	LV432525	1 support for 3 moving connectors; NSX400/630 circuit breaker accessory	Yes	Yes
32526	Terminal extension insulated long for plug in base NS400 to 630 3P	LV432526	2 long insulated terminal ext for base; NSX400/630 circuit breaker accessory	Yes	Yes
32527	Terminal extension insulated long for plug in base NS400 to 630 4P		Different packaging	Yes	
32532	Withdrawable chassis (fixed part) (NS400/630)	LV432532	Chassis side plates for 3/4P base; NSX400/630 circuit breaker accessory	No	Yes
32533	Withdrawable chassis (moving part) (NS400/630)	LV432533	Chassis side plates for 3/4P breaker; NSX400/630 circuit breaker accessory	No	Yes
32534	Extension escutcheon (D/O chassis) (NS400/630)	LV432534	Escutcheon collar for toggle (chassis); NSX400/630 circuit breaker accessory	No	No
32538	Complete set for plug-in 3P (NS400/630)	LV432538	3P Compact plug-in base kit; NSX400/630 circuit breaker accessory	No	No
32539	Complete set for plug-in 4P (NS400/630)	LV432539	4P Compact plug-in base kit; NSX400/630 circuit breaker accessory	No	No
32540	Complete set for Vigi into plug-in 3P(NS400/630)	LV432540	3P Vigicomact plug-in base kit; NSX400/630 circuit breaker accessory	No	No
32541	Complete set for Vigi into plug-in 4P(NS400/630)	LV432541	4P Vigicomact plug-in base kit; NSX400/630 circuit breaker accessory	No	No
32542	Complete set for draw out 3P (NS400/630)		Different packaging	No	No
32543	Complete set for draw out 4P (NS400/630)		Different packaging	No	No
32544	Complete set for Vigi into draw out 3P (NS400/630)		Different packaging	No	No
32545	Complete set for Vigi into draw out 4P (NS400/630)		Different packaging	No	No
32551	auxiliary contact 1 OC and 1 SD and 1 SDE communicating		Replaced by Micrologic	No	
32553	Toggle extension (NS400/630)	LV432553	Toggle extension; NSX400/630 circuit breaker accessory	Yes	Yes
32556	Escutcheon for direct toggle (NS400/630)			No	
32558	Escutcheon (motor mech./rotary handle) (NS400/630)	LV432558	IP40 escutcheon for all control types; NSX400/630 circuit breaker accessory	Yes	Yes
32560	Rubber toggle cover (NS400/630)	LV432560	IP43 rubber toggle cover; NSX400/630 circuit breaker accessory	No	No
32562	2 short terminal shields 3P (NS400/630)		Different packaging	Yes	
32563	2 short terminal shields 4P (NS400/630)		Different packaging	Yes	
32564	2 long terminal shields 3P (NS400/630)		Different packaging	Yes	
32565	2 long terminal shields 4P (NS400/630)		Different packaging	Yes	
32566	1 voltage indicator (NS400/630)	LV432566	220-550 V AC voltage presence indicator; NSX400/630 circuit breaker accessory	Yes	Yes
32570	6 interphase barriers (NS400/630)	LV432570	6 interphase barriers; INV/INS NSX400/630 circuit breaker accessory	Yes	Yes
32571	6 phase barriers for plug-in base (NS400/630)		Different packaging	Yes	
32576	2 rear insulating screens 3P (52.5 mm) (NS400/630)		Different packaging	Yes	
32577	2 rear insulating screens 4P (52.5 mm) (NS400/630)		Different packaging	Yes	
32578	2 rear insulating screens 3P (70 mm) (NS400/630)	LV432578	2 insulating screens 3P (70 mm pitch); NSX400/630 circuit breaker accessory	Yes	Yes
32579	2 rear insulating screens 4P (70 mm) (NS400/630)	LV432579	2 insulating screens 4P (70 mm pitch); NSX400/630 circuit breaker accessory	Yes	Yes
32580	2 long term. shields 3P U > 600 V (45 mm) (NS400/630)		Different packaging	Yes	
32581	2 long term. shields 4P U > 600 V (45 mm) (NS400/630)		Different packaging	Yes	
32582	2 long term. shields 3P U > 600 V (52.5 mm) (NS400/630)		Different packaging	Yes	
32583	2 long term. shields 4P U > 600 V (52.5 mm) (NS400/630)		Different packaging	Yes	
32584	3P terminal shields adaptor for plug-in base (set of 2) NS400/630		Different packaging	Yes	
32585	4P terminal shields adaptor for plug-in base (set of 2) NS400/630		Different packaging	Yes	
32586	2 long term. shields 3P for plug-in base (NS400/630)		Different packaging	Yes	
32587	2 long term. shields 3P for plug-in base (NS400/630)		Different packaging	Yes	
32588	Long term. shields and 3P adaptor for plug-in-base (NS400/630)		Different packaging	Yes	
32589	Long term. shields and 4P adaptor for plug-in-base (NS400/630)		Different packaging	Yes	
32591	Phase barriers and 3P adaptor for plug-in-base (NS400/630)		Different packaging	Yes	
32592	Phase barriers and 4P adaptor for plug-in-base (NS400/630)		Different packaging	Yes	
32597	Front rotary handle NS400 to 630 black handle	LV432597	Direct standard rotary handle; NSX400/630 circuit breaker accessory	No	Yes
32598	Front rotary handle NS400 to 630 black handle	LV432598	Extended standard rotary handle; NSX400/630 circuit breaker accessory	No	Yes
32599	Front rotary handle NS400 to 630 red handle	LV432599	Direct red-yellow rotary handle; NSX400/630 circuit breaker accessory	No	Yes
32600	Front rotary handle NS400 to 630 red handle	LV432600	Extended red-yellow rotary handle; NSX400/630 circuit breaker accessory	No	Yes

Compact NS Cat. number	Designation	Compact NSX Cat. number	Designation	Compatibility	
				NS/NSX	NSX/NS
32602	CNOMO accessory for rotary handle (NS400/630)	LV432602	Rotary handle CNOMO conversion accessory; NSX400/630 circuit breaker accessory	No	Yes
32603	Front rotary handle NS400 to 630 black handle	LV432603	Telescopic rotary handle (500 mm shaft); NSX400/630 circuit breaker accessory	No	Yes
32604	Rotary handle lock support (W/O lock) (NS400/630)	LV432604	Rot handle keylock adapter (w/o keylock); NSX400/630 circuit breaker accessory	Yes	Yes
32605	Auxiliary contact 1 OC earlybreak	LV432605	1 early-break contact; NSX400/630 circuit breaker accessory	No	Yes
32606	Accessory for MCC type rotary handle (NS400/630)	LV432606	Rotary handle MCC conversion accessory; NSX400/630 circuit breaker accessory	Yes	Yes
32607	Extended rotary handle and telesc. shaft blokset (NS400/630)	LV432603	Blokset telescopic rotary handle; NSX400/630 circuit breaker accessory	No	Yes
32609	Base plate with mechanical interlocking Compact NS400 to 630		NSX cat. number same as NS cat. number		
32610	Base plate with mechanical and electrical interlocking Compact NS400 to 630 IVE/AC		NSX cat. number same as NS cat. number		
32611	Base plate with mechanical and electrical interlocking Compact NS400 to 630 IVE/DC		NSX cat. number same as NS cat. number		
32614	Interlocking for devices with toggle Compact NS400 to 630	LV432614	Mechanical interlock for toggles; NSX400/630 circuit breaker accessory	No	No
32618	Accessory for sourcechangeover switch adaptation kit for NS100 to 250		NSX cat. number same as NS cat. number	Yes	
32619	Accessory for sourcechangeover switch downstream 3P busbar coupling, 630 A		NSX cat. number same as NS cat. number	Yes	
32620	Accessory for sourcechangeover switch downstream 4P busbar coupling, 630 A		NSX cat. number same as NS cat. number	Yes	
32621	Interlocking for devices with rotary handle Compact NS400 to 630	LV432621	Mechanical interlock for rot handles; INV/INS NSX400/630 circuit breaker accessory	Yes	Yes
32623	Busbar adaptor (NS400/630)		NSX cat. number same as NS cat. number	Yes	Yes
32631	Fixed toggle padlock. device (NS400/630)	LV432631	Fixed locking device for 3 padlocks; NSX400/630 circuit breaker accessory	No	Yes
32639	Motor mechanism Compact MT400 48 to 60 V AC	LV432639	48-60 V AC 50/60 Hz MT400/630; NSX400/630 circuit breaker motor mech. module	No	Yes
32640	Motor mechanism Compact MT400 110 to 130 V AC	LV432640	110-130 V AC 50/60 Hz MT400/630; NSX400/630 circuit breaker motor mech. module	No	Yes
32641	Motor mechanism Compact MT400 220 to 240 V AC	LV432641	220-240 V 50/60 Hz 208-277 V 60 Hz MT400/630; NSX400/630 breaker motor mech. module	No	Yes
32642	Motor mechanism Compact MT400 380 to 415 V AC	LV432642	380-415 V AC 50/60 Hz MT400/630; NSX400/630 circuit breaker motor mech. module	No	Yes
32643	Motor mechanism Compact MT400 24 to 30 V DC	LV432643	24-30 V DC MT400/630; NSX400/630 circuit breaker motor mech. module	No	Yes
32644	Motor mechanism Compact MT400 48 to 60 V DC	LV432644	48-60 V DC MT400/630; NSX400/630 circuit breaker motor mech. module	No	Yes
32645	Motor mechanism Compact MT400 110 to 130 V DC	LV432645	110-130 V DC MT400/630; NSX400/630 circuit breaker motor mech. module	No	Yes
32646	Motor mechanism Compact MT400 250 V DC	LV432646	250 V DC MT400/630; NSX400/630 circuit breaker motor mech. module	No	Yes
32647	Motor mechanism Compact MT400 440 to 480 V AC	LV432647	440-480V AC 60 Hz Hz MT400/630; NSX400/630 circuit breaker motor mech. module	No	Yes
32648	Operation counter mechanical 5 digit display for NS400 to 630	LV432648	MT400/630 operations counter; NSX400/630 circuit breaker accessory	Yes	Yes
32649	Motor keylock support without keylock (NS400/630)	LV432649	Motor mech. keylock adapter + keylock; NSX400/630 circuit breaker accessory	Yes	Yes
32652	Motor mechanism Compact MT400 220 to 240 V AC	LV432652	Communicating MT400/630 220-240V 50/60 Hz; NSX400/630 breaker motor mech. module	No	No
32653	CT module 3P 3CT 400 A/5 A with voltage outputs	LV432653	3P 400/5 A CT module + voltage outputs; NSX400/630 circuit breaker accessory	No	No
32654	CT module 4P 3CT 400 A/5 A with voltage outputs	LV432654	4P 400/5 A CT module + voltage outputs; NSX400/630 circuit breaker accessory	No	No
32655	Ammeter module for NS400 3P 400 A	LV432655	3P 400 A ammeter module; NSX400/630 circuit breaker accessory	No	No
32656	Ammeter module for NS400 4P 400 A	LV432656	4P 400 A ammeter module; INV/INS NSX400/630 circuit breaker accessory	No	No
32657	Current transformer module for NS400 3P 400 A	LV432657	3P 400/5 A current transfo module; NSX400/630 circuit breaker accessory	No	No
32658	Current transformer module for NS400 4P 400 A	LV432658	4P 400/5 A current transfo module; INV/INS NSX400/630 circuit breaker accessory	No	No
32659	Insulation monitoring module for NS400 to 630 3P	LV432659	3P TNS/TT insulation monitoring module; NSX400/630 circuit breaker accessory	No	No
32660	Insulation monitoring module for NS400 to 630 4P	LV432660	4P TNS/TT insulation monitoring module; NSX400/630 circuit breaker accessory	No	No
32665	Weatherproof enclosure for Compact NS400 to 630 plastic	LV432665	Insulating enclosure + standard extended rotary handle; NSX400/630 IP55 enclosure	Yes	
32666	Weatherproof enclosure for Vigicompact NS400 to 630 plastic	LV432666	Insulating enclosure + standard extended rotary handle; Vigi NSX400/630 IP55 enclosure	Yes	
32670	Circuit breaker Compact NS400N STR23SP 400 A 3P 3d		Replaced by Micrologic 2		

Substitution table

Compatibility of components

Compact NS to NSX

and Compact NSX to NS

Compact NS Cat. number	Designation	Compact NSX Cat. number	Designation	Compatibility	
				NS/NSX	NSX/NS
32671	Circuit breaker Compact NS400N STR23SP 250 A 3P 3d		Replaced by Micrologic 2		
32672	Circuit breaker Compact NS400N STR23SP 150 A 3P 3d		Replaced by Micrologic 2		
32693	Circuit breaker Compact NS400N STR23SE 400 A 3P 3d	LV432693	3P3D Micrologic 2.3 400 A NSX400N; Compact circuit breaker		
32694	Circuit breaker Compact NS400N STR23SE 400 A 4P 4d	LV432694	4P4D Micrologic 2.3 400 A NSX400N; Compact circuit breaker		
32695	Circuit breaker Compact NS400H STR23SE 400 A 3P 3d	LV432695	3P3D Micrologic 2.3 400 A NSX400H; Compact circuit breaker		
32696	Circuit breaker Compact NS400H STR23SE 400 A 4P 4d	LV432696	4P4D Micrologic 2.3 400 A NSX400H; Compact circuit breaker		
32697	Circuit breaker Compact NS400L STR23SE 400 A 3P 3d		Order breaker + trip unit		
32698	Circuit breaker Compact NS400L STR23SE 400 A 4P 4d		Order breaker + trip unit		
32699	Circuit breaker Compact NS400N STR53UE 400 A 3P 3d	LV432699	3P3D Micrologic 5.3 A 400 A NSX400N; Compact circuit breaker		
32700	Circuit breaker Compact NS400N STR53UE 400 A 4P 4d	LV432700	4P4D Micrologic 5.3 A 400 A NSX400N; Compact circuit breaker		
32701	Circuit breaker Compact NS400H STR53UE 400 A 3P 3d	LV432701	3P3D Micrologic 5.3 A 400 A NSX400H; Compact circuit breaker		
32702	Circuit breaker Compact NS400H STR53UE 400 A 4P 4d	LV432702	4P4D Micrologic 5.3 A 400 A NSX400H; Compact circuit breaker		
32703	Circuit breaker Compact NS400L STR53UE 400 A 3P 3d		Order breaker + trip unit		
32704	Circuit breaker Compact NS400L STR53UE 400 A 4P 4d		Order breaker + trip unit		
32707	Circuit breaker Compact NS400N STR23SE 250 A 3P 3d	LV432707	3P3D Micrologic 2.3 250 A NSX400N; Compact circuit breaker		
32708	Circuit breaker Compact NS400N STR23SE 250 A 4P 4d	LV432708	4P4D Micrologic 2.3 250 A NSX400N; Compact circuit breaker		
32709	Circuit breaker Compact NS400H STR23SE 250 A 3P 3d	LV432709	3P3D Micrologic 2.3 250 A NSX400H; Compact circuit breaker		
32710	Circuit breaker Compact NS400H STR23SE 250 A 4P 4d	LV432710	4P4D Micrologic 2.3 250 A NSX400H; Compact circuit breaker		
32711	Circuit breaker Compact NS400L STR23SE 250 A 3P 3d		Order breaker + trip unit		
32712	Circuit breaker Compact NS400L STR23SE 250 A 4P 4d		Order breaker + trip unit		
32713	Circuit breaker Compact NS400N STR53UE 250 A 3P 3d		Order breaker + trip unit		
32714	Circuit breaker Compact NS400N STR53UE 250 A 4P 4d		Order breaker + trip unit		
32715	Circuit breaker Compact NS400H STR53UE 250 A 3P 3d		Order breaker + trip unit		
32716	Circuit breaker Compact NS400H STR53UE 250 A 4P 4d		Order breaker + trip unit		
32717	Circuit breaker Compact NS400L STR53UE 250 A 3P 3d		Order breaker + trip unit		
32718	Circuit breaker Compact NS400L STR53UE 250 A 4P 4d		Order breaker + trip unit		
32719	Circuit breaker Compact NS400N STR23SE 150 A 3P 3d		Order breaker + trip unit		
32720	Circuit breaker Compact NS400N STR23SE 150 A 4P 4d		Order breaker + trip unit		
32721	Circuit breaker Compact NS400H STR23SE 150 A 3P 3d		Order breaker + trip unit		
32722	Circuit breaker Compact NS400H STR23SE 150 A 4P 4d		Order breaker + trip unit		
32723	Circuit breaker Compact NS400L STR23SE 150 A 3P 3d		Order breaker + trip unit		
32724	Circuit breaker Compact NS400L STR23SE 150 A 4P 4d		Order breaker + trip unit		
32725	Circuit breaker Compact NS400N STR53UE 150 A 3P 3d		Order breaker + trip unit		
32726	Circuit breaker Compact NS400N STR53UE 150 A 4P 4d		Order breaker + trip unit		
32727	Circuit breaker Compact NS400H STR53UE 150 A 3P 3d		Order breaker + trip unit		
32728	Circuit breaker Compact NS400H STR53UE 150 A 4P 4d		Order breaker + trip unit		
32729	Circuit breaker Compact NS400L STR53UE 150 A 3P 3d		Order breaker + trip unit		
32730	Circuit breaker Compact NS400L STR53UE 150 A 4P 4d		Order breaker + trip unit		
32733	Circuit breaker Vigicompact NS400N STR23SE 400 A 3P 3d 300 to 30000 mA	LV432733	3P3D Micrologic 2.3 400 A Vigi MB NSX400N; Vigicompact circuit breaker		

Compact NS Cat. number	Designation	Compact NSX Cat. number	Designation	Compatibility	
				NS/NSX	NSX/NS
32734	Circuit breaker Vigicompact NS400N STR23SE 400 A 4P 4d 300 to 30000 mA	LV432734	4P4D Micrologic 2.3 400 A Vigi MB NSX400N; Vigicompact circuit breaker		
32750	Circuit breaker Compact NS400H MA 320 A 3P 3d	LV432750	3P3D Micrologic 1.3 M 320 A NSX400H; Compact circuit breaker		
32751	Circuit breaker Compact NS400L MA 320 A 3P 3d		Order breaker + trip unit		
32756	Molded case switch-disconnector Compact NS400 NA 3P 400 A	LV432756	3P Micrologic 0.3 NA NSX400NA; Compact switch-disconnector		
32757	Molded case switch-disconnector Compact NS400 NA 4P 400 A	LV432757	4P Micrologic 0.3 NA NSX400NA; Compact switch-disconnector		
32803	Basic frame Compact NS630N 630 A 3P fixed	LV432803	3P NSX630N without trip unit; Compact circuit breaker		
32804	Basic frame Compact NS630H 630 A 3P fixed	LV432804	3P NSX630H without trip unit; Compact circuit breaker		
32805	Basic frame Compact NS630L 630 A 3P fixed	LV432805	3P NSX630L without trip unit; Compact circuit breaker		
32808	Basic frame Compact NS630N 630 A 4P fixed	LV432808	4P NSX630N without trip unit; Compact circuit breaker		
32809	Basic frame Compact NS630H 630 A 4P fixed	LV432809	4P NSX630H without trip unit; Compact circuit breaker		
32810	Basic frame Compact NS630L 630 A 4P fixed	LV432810	4P NSX630L without trip unit; Compact circuit breaker		
32839	Motor mechanism Compact MT630 48 to 60 V AC	LV432639	48-60 V AC 50/60 Hz MT400/630; NSX400/630 circuit breaker motor mech. module	No	Yes
32840	Motor mechanism Compact MT630 110 to 130 V AC	LV432640	110-130 V AC 50/60 Hz MT400/630; NSX400/630 circuit breaker motor mech. module	No	Yes
32841	Motor mechanism Compact MT630 220 to 240 V AC	LV432641	220-240 V 50/60 Hz 208-277 V 60 Hz MT400/630; NSX400/630 breaker motor mech. module	No	Yes
32842	Motor mechanism Compact MT630 380 to 415 V AC	LV432642	380-415 V AC 50/60 Hz MT400/630; NSX400/630 circuit breaker motor mech. module	No	Yes
32843	Motor mechanism Compact MT630 24 to 30 V DC	LV432643	24-30 V DC MT400/630; NSX400/630 circuit breaker motor mech. module	No	Yes
32844	Motor mechanism Compact MT630 48 to 60 V DC	LV432644	48-60 V DC MT400/630; NSX400/630 circuit breaker motor mech. module	No	Yes
32845	Motor mechanism Compact MT630 110 to 130 V DC	LV432645	110-130 V DC MT400/630; NSX400/630 circuit breaker motor mech. module	No	Yes
32846	Motor mechanism Compact MT630 250 V DC	LV432646	250 V DC MT400/630; NSX400/630 circuit breaker motor mech. module	No	Yes
32847	Motor mechanism Compact MT630 440 to 480 V AC	LV432647	440-480V AC 60 Hz Hz MT400/630; NSX400/630 circuit breaker motor mech. module	No	Yes
32848	Motor mechanism Compact MT630 220 to 240 V AC	LV432652	Communicating MT400/630 220-240V 50/60 Hz; NSX400/630 breaker motor mech. module	No	No
32855	Ammeter module for NS630 3P 630 A	LV432855	3P 630 A ammeter module; NSX630 circuit breaker accessory	No	No
32856	Ammeter module for NS630 4P 630 A	LV432856	4P 630 A ammeter module; INV/INS NSX630 circuit breaker accessory	No	No
32857	Current transformer module for NS630 3P 600 A	LV432857	3P 600/5 A current transfo module; NSX630 circuit breaker accessory	No	No
32858	Current transformer module for NS630 4P 600 A	LV432858	4P 600/5 A current transfo module; INV/INS NSX630 circuit breaker accessory	No	No
32861	CT module 3P 3CT 600A/5A with voltage outputs	LV432861	3P 600/5 A CT module + voltage outputs; NSX630 circuit breaker accessory	No	No
32862	CT module 4P 3CT 600A/5A with voltage outputs	LV432862	4P 600/5 A CT module + voltage outputs; NSX630 circuit breaker accessory	No	No
32893	Circuit breaker Compact NS630N STR23SE 630 A 3P 3d	LV432893	3P3D Micrologic 2.3 630 A NSX630N; Compact circuit breaker		
32894	Circuit breaker Compact NS630N STR23SE 630 A 4P 4d	LV432894	4P4D Micrologic 2.3 630 A NSX630N; Compact circuit breaker		
32895	Circuit breaker Compact NS630H STR23SE 630 A 3P 3d	LV432895	3P3D Micrologic 2.3630 A NSX630H; Compact circuit breaker		
32896	Circuit breaker Compact NS630H STR23SE 630 A 4P 4d	LV432896	4P4D Micrologic 2.3630 A NSX630H; Compact circuit breaker		
32897	Circuit breaker Compact NS630L STR23SE 630 A 3P 3d		Order breaker + trip unit		
32898	Circuit breaker Compact NS630L STR23SE 630 A 4P 4d		Order breaker + trip unit		
32899	Circuit breaker Compact NS630N STR53UE 630 A 3P 3d	LV432899	3P3D Micrologic 5.3 A 630 A NSX630N; Compact circuit breaker		
32900	Circuit breaker Compact NS630N STR53UE 630 A 4P 4d	LV432900	4P4D Micrologic 5.3 A 630 A NSX630N; Compact circuit breaker		
32901	Circuit breaker Compact NS630H STR53UE 630 A 3P 3d	LV432901	3P3D Micrologic 5.3 A 630 A NSX630H; Compact circuit breaker		
32902	Circuit breaker Compact NS630H STR53UE 630 A 4P 4d	LV432902	4P4D Micrologic 5.3 A 630 A NSX630H; Compact circuit breaker		
32903	Circuit breaker Compact NS630L STR53UE 630 A 3P 3d		Order breaker + trip unit		
32904	Circuit breaker Compact NS630L STR53UE 630 A 4P 4d		Order breaker + trip unit		
32933	Circuit breaker Vigicompact NS630N STR23SE 630 A 3P 3d 300 to 30000 mA	LV432933	3P3D Micrologic 2.3 630 A Vigi MB NSX630N; Vigicompact circuit breaker		
32934	Circuit breaker Vigicompact NS630N STR23SE 630 A 4P 4d 300 to 30000 mA	LV432934	4P4D Micrologic 2.3 630 A Vigi MB NSX630N; Vigicompact circuit breaker		
32950	Circuit breaker Compact NS630H MA 500 A 3P 3d	LV432950	3P3D Micrologic 1.3 M 500 A NSX630H; Compact circuit breaker		
32951	Circuit breaker Compact NS630L MA 500 A 3P 3d		Order breaker + trip unit		

Substitution table

Compatibility of components

Compact NS to NSX

and Compact NSX to NS

Compact NS Cat. number	Designation	Compact NSX Cat. number	Designation	Compatibility	
				NS/NSX	NSX/NS
32956	Molded case switch-disconnector Compact NS630 NA 3P 630 A	LV432956	3P Micrologic 0.3 NA NSX630NA; Compact switch-disconnector		
32957	Molded case switch-disconnector Compact NS630 NA 4P 630 A	LV432957	4P Micrologic 0.3 NA NSX630NA; Compact switch-disconnector		
32960	Trip unit STR23SE (NS400/630)		Replaced by Micrologic 2	No	
32963	Trip unit STR53UE F (NS400/630)		Replaced by Micrologic 2	No	
34550	Elect. trip unit STR22SE AB100 4P4T (NS100/250)	LV434550	4P4D Micrologic 2.2 AB 100 A trip unit; for NSX100-250 circuit breaker	No	No
34551	Elect. trip unit STR22SE AB160 4P4T (NS160/250)	LV434551	4P4D Micrologic 2.2 AB 160 A trip unit; for NSX160/250 circuit breaker	No	No
34552	4P subscribed circuit breaker connection accessory (NS100/160AB)			Yes	
34554	Elect. trip unit STR22SE AB240 4P4T (NS250)	LV434554	4P4D Micrologic 2.2 AB 240 A trip unit; for NSX250 circuit breaker	No	No
34555	4P subscribed circuit breaker connection accessory (NS240AB)			Yes	
34557	Elect. trip unit STR23SE AB400 4P4T (NS400/630)	LV434557	4P4D Micrologic 2.3 AB 400 A trip unit; for NSX400/630 circuit breaker	No	No
34558	4P subscribed circuit breaker connection accessory (NS400AB)			Yes	
34562	Circuit breaker NS100N STR22SE AB100 4P FFC w/o accessory	LV434562	4P4D Micrologic 2.2 AB 100 A NSX100F; Compact circuit breaker		
34563	Circuit breaker	LV434563	4P4D Micrologic 2.2 AB 160 A NSX160F; Compact circuit breaker		
34564	Circuit breaker NS250N STR22SE AB240 4P FFC w/o accessory	LV434564	4P4D Micrologic 2.2 AB 240 A NSX250F; Compact circuit breaker		
34565	Circuit breaker NS400N STR23SE AB400 AP FFC w/o accessory	LV434565	4P4D Micrologic 2.3 AB 400 A NSX400F; Compact circuit breaker		
34572	Vigi MH NS100N STR22SE AB100 4P FFC w/o accessory	LV434572	4P Micrologic 2.2AB 100 A Vigi MH NSX100F; Vigicomact circuit breaker		
34573	Vigi MH NS160N STR22SE AB160 4P FFC w/o accessory	LV434573	4P Micrologic 2.2AB 160 A Vigi MH NSX160F; Vigicomact circuit breaker		
34574	Vigi MH NS250N STR22SE AB240 4P FFC w/o accessory	LV434574	4P Micrologic 2.2AB 240 A Vigi MH NSX250F; Vigicomact circuit breaker		
34575	Vigi MB NS400 STR23SE AB400 4P FFC w/o accessory	LV434575	4P Micrologic 2.3AB 400 A Vigi MH NSX400F; Vigicomact circuit breaker		
34849	Ammeter block I max 100 A (NS100/250)	LV434849	3P 100 A I max ammeter module; NSX100-250 circuit breaker accessory	No	No
34850	Ammeter block I max 160 A (NS100/250)	LV434850	3P 160 A I max ammeter module; NSX160/250 circuit breaker accessory	No	No
34851	Ammeter block I max 250 A (NS100/250)	LV434851	3P 250 A I max ammeter module; NSX250 circuit breaker accessory	No	No
34852	Ammeter block I max 400 A (NS400)	LV434852	3P 400 A I max ammeter module; NSX400/630 circuit breaker accessory	No	No
34853	Ammeter block I max 630 A (NS630)	LV434853	3P 630 A I max ammeter module; NSX630 circuit breaker accessory	No	No
35850	Circuit breaker NS100 SX TM100D 3P3T	LV429840	3P3D TM100D NSX100N; Compact circuit breaker		
35851	Circuit breaker NS100 SX TM80D 3P3T	LV429841	3P3D TM80D NSX100N; Compact circuit breaker		
35852	Circuit breaker NS100 SX TM63T 3P3T	LV429842	3P3D TM63D NSX100N; Compact circuit breaker		
35853	Circuit breaker NS100 SX TM50D 3P3T	LV429843	3P3D TM50D NSX100N; Compact circuit breaker		
35854	Circuit breaker NS100 SX TM40D 3P3T	LV429844	3P3D TM40D NSX100N; Compact circuit breaker		
35855	Circuit breaker NS100 SX TM32D 3P3T	LV429845	3P3D TM32D NSX100N; Compact circuit breaker		
35856	Circuit breaker NS100 SX TM25D 3P3T	LV429846	3P3D TM25D NSX100N; Compact circuit breaker		
35857	Circuit breaker NS100 SX TM16D 3P3T	LV429847	3P3D TM16D NSX100N; Compact circuit breaker		
35860	Circuit breaker NS100 SX TM100D 4P3T	LV429850	4P3D TM100D NSX100N; Compact circuit breaker		
35861	Circuit breaker NS100 SX TM80D 4P3T	LV429851	4P3D TM80D NSX100N; Compact circuit breaker		
35862	Circuit breaker NS100 SX TM63T 4P3T	LV429852	4P3D TM63D NSX100N; Compact circuit breaker		
35863	Circuit breaker NS100 SX TM50D 4P3T	LV429853	4P3D TM50D NSX100N; Compact circuit breaker		
35864	Circuit breaker NS100 SX TM40D 4P3T	LV429854	4P3D TM40D NSX100N; Compact circuit breaker		
35865	Circuit breaker NS100 SX TM32D 4P3T	LV429855	4P3D TM32D NSX100N; Compact circuit breaker		
35866	Circuit breaker NS100 SX TM25D 4P3T	LV429856	4P3D TM25D NSX100N; Compact circuit breaker		
35867	Circuit breaker NS100 SX TM16D 4P3T	LV429857	4P3D TM16D NSX100N; Compact circuit breaker		
35870	Circuit breaker NS100 SX TM100D 4P4T	LV429860	4P4D TM100D NSX100N; Compact circuit breaker		
35871	Circuit breaker NS100 SX TM80D 4P4T	LV429861	4P4D TM80D NSX100N; Compact circuit breaker		
35872	Circuit breaker NS100 SX TM63T 4P4T	LV429862	4P4D TM63D NSX100N; Compact circuit breaker		
35873	Circuit breaker NS100 SX TM50D 4P4T	LV429863	4P4D TM50D NSX100N; Compact circuit breaker		
35874	Circuit breaker NS100 SX TM40D 4P4T	LV429864	4P4D TM40D NSX100N; Compact circuit breaker		
35875	Circuit breaker NS100 SX TM32D 4P4T	LV429865	4P4D TM32D NSX100N; Compact circuit breaker		
35876	Circuit breaker NS100 SX TM25D 4P4T	LV429866	4P4D TM25D NSX100N; Compact circuit breaker		
35877	Circuit breaker NS100 SX TM16D 4P4T	LV429867	4P4D TM16D NSX100N; Compact circuit breaker		
35880	Circuit breaker NS100 SX TM100D 4P3T and N/2		Replaced by Micrologic 2		
35881	Circuit breaker NS100 SX TM80D 4P3T and N/2		Replaced by Micrologic 2		
35890	Circuit breaker NS160 SX TM160D 3P3T	LV430840	3P3D TM160D NSX160N; Compact circuit breaker		
35891	Circuit breaker NS160 SX TM125D 3P3T	LV430841	3P3D TM125D NSX160N; Compact circuit breaker		
35892	Circuit breaker NS160 SX TM100D 3P3T	LV430842	3P3D TM100D NSX160N; Compact circuit breaker		
35893	Circuit breaker NS160 SX TM80D 3P3T	LV430843	3P3D TM80D NSX160N; Compact circuit breaker		
35894	Circuit breaker NS160 SX TM63D 3P3T	LV430844	3P3D TM63D NSX160N; Compact circuit breaker		
35895	Circuit breaker NS160 SX TM50D 3P3T	LV430845	3P3D TM50D NSX160N; Compact circuit breaker		

Compact NS Cat. number	Designation	Compact NSX Cat. number	Designation	Compatibility	
				NS/NSX	NSX/NS
35896	Circuit breaker NS160 SX TM40D 3P3T	LV430846	3P3D TM40D NSX160N; Compact circuit breaker		
35900	Circuit breaker NS160 SX TM160D 4P3T	LV430850	4P3D TM160D NSX160N; Compact circuit breaker		
35901	Circuit breaker NS160 SX TM125D 4P3T	LV430851	4P3D TM125D NSX160N; Compact circuit breaker		
35902	Circuit breaker NS160 SX TM100D 4P3T	LV430852	4P3D TM100D NSX160N; Compact circuit breaker		
35903	Circuit breaker NS160 SX TM80D 4P3T	LV430853	4P3D TM80D NSX160N; Compact circuit breaker		
35904	Circuit breaker NS160 SX TM63T 4P3T	LV430854	4P3D TM63D NSX160N; Compact circuit breaker		
35905	Circuit breaker NS160 SX TM50D 4P3T	LV430855	4P3D TM50D NSX160N; Compact circuit breaker		
35906	Circuit breaker NS160 SX TM40D 4P3T	LV430856	4P3D TM40D NSX160N; Compact circuit breaker		
35910	Circuit breaker NS160 SX TM160D 4P4T	LV430860	4P4D TM160D NSX160N; Compact circuit breaker		
35911	Circuit breaker NS160 SX TM125D 4P4T	LV430861	4P4D TM125D NSX160N; Compact circuit breaker		
35912	Circuit breaker NS160 SX TM100D 4P4T	LV430862	4P4D TM100D NSX160N; Compact circuit breaker		
35913	Circuit breaker NS160 SX TM80D 4P4T	LV430863	4P4D TM80D NSX160N; Compact circuit breaker		
35914	Circuit breaker NS160 SX TM63T 4P4T	LV430864	4P4D TM63D NSX160N; Compact circuit breaker		
35915	Circuit breaker NS160 SX TM50D 4P4T	LV430865	4P4D TM50D NSX160N; Compact circuit breaker		
35916	Circuit breaker NS160 SX TM40D 4P4T	LV430866	4P4D TM40D NSX160N; Compact circuit breaker		
35920	Circuit breaker NS160 SX TM160D 4P3T and N/2		Replaced by Micrologic 2		
35921	Circuit breaker NS160 SX TM125D 4P3T and N/2		Replaced by Micrologic 2		
35922	Circuit breaker NS160 SX TM100D 4P3T and N/2		Replaced by Micrologic 2		
35923	Circuit breaker NS160 SX TM80D 4P3T and N/2		Replaced by Micrologic 2		
35930	Circuit breaker NS250 SX TM250D 3P3T	LV431830	3P3D TM250D NSX250N; Compact circuit breaker		
35931	Circuit breaker NS250 SX TM200D 3P3T	LV431831	3P3D TM200D NSX250N; Compact circuit breaker		
35932	Circuit breaker NS250 SX TM160D 3P3T	LV431832	3P3D TM160D NSX250N; Compact circuit breaker		
35933	Circuit breaker NS250 SX TM125D 3P3T	LV431833	3P3D TM125D NSX250N; Compact circuit breaker		
35934	Circuit breaker NS250 SX TM100D 3P3T	LV431834	3P3D TM100D NSX250N; Compact circuit breaker		
35935	Circuit breaker NS250 SX TM80D 3P3T	LV431835	3P3D TM80D NSX250N; Compact circuit breaker		
35936	Circuit breaker NS250 SX TM63T 3P3T	LV431836	3P3D TM63D NSX250N; Compact circuit breaker		
35937	Circuit breaker NS250 SX TM50D 3P3T	LV431837	3P3D TM50D NSX250N; Compact circuit breaker		
35938	Circuit breaker NS250 SX TM40D 3P3T	LV431838	3P3D TM40D NSX250N; Compact circuit breaker		
35940	Circuit breaker NS250 SX TM250D 4P3T	LV431840	4P3D TM250D NSX250N; Compact circuit breaker		
35941	Circuit breaker NS250 SX TM200D 4P3T	LV431841	4P3D TM200D NSX250N; Compact circuit breaker		
35942	Circuit breaker NS250 SX TM160D 4P3T	LV431842	4P3D TM160D NSX250N; Compact circuit breaker		
35943	Circuit breaker NS250 SX TM125D 4P3T	LV431843	4P3D TM125D NSX250N; Compact circuit breaker		
35944	Circuit breaker NS250 SX TM100D 4P3T	LV431844	4P3D TM100D NSX250N; Compact circuit breaker		
35945	Circuit breaker NS250 SX TM80D 4P3T	LV431845	4P3D TM80D NSX250N; Compact circuit breaker		
35946	Circuit breaker NS250 SX TM63T 4P3T	LV431846	4P3D TM63D NSX250N; Compact circuit breaker		
35947	Circuit breaker NS250 SX TM50D 4P3T	LV431847	4P3D TM50D NSX250N; Compact circuit breaker		
35948	Circuit breaker NS250 SX TM40D 4P3T	LV431848	4P3D TM40D NSX250N; Compact circuit breaker		
35950	Circuit breaker NS250 SX TM250D 4P4T	LV431850	4P4D TM250D NSX250N; Compact circuit breaker		
35951	Circuit breaker NS250 SX TM200D 4P4T	LV431851	4P4D TM200D NSX250N; Compact circuit breaker		
35952	Circuit breaker NS250 SX TM160D 4P4T	LV431852	4P4D TM160D NSX250N; Compact circuit breaker		
35953	Circuit breaker NS250 SX TM125D 4P4T	LV431853	4P4D TM125D NSX250N; Compact circuit breaker		
35954	Circuit breaker NS250 SX TM100D 4P4T	LV431854	4P4D TM100D NSX250N; Compact circuit breaker		
35955	Circuit breaker NS250 SX TM80D 4P4T	LV431855	4P4D TM80D NSX250N; Compact circuit breaker		
35956	Circuit breaker NS250 SX TM63T 4P4T	LV431856	4P4D TM63D NSX250N; Compact circuit breaker		
35957	Circuit breaker NS250 SX TM50D 4P4T	LV431857	4P4D TM50D NSX250N; Compact circuit breaker		
35958	Circuit breaker NS250 SX TM40D 4P4T	LV431858	4P4D TM40D NSX250N; Compact circuit breaker		
35960	Circuit breaker NS250 SX TM250D 4P3T and N/2		Replaced by Micrologic 2		
35961	Circuit breaker NS250 SX TM200D 4P3T and N/2		Replaced by Micrologic 2		
35962	Circuit breaker NS250 SX TM160D 4P3T and N/2		Replaced by Micrologic 2		
35963	Circuit breaker NS250 SX TM125D 4P3T and N/2		Replaced by Micrologic 2		
35964	Circuit breaker NS250 SX TM100D 4P3T and N/2		Replaced by Micrologic 2		
35965	Circuit breaker NS250 SX TM80D 4P3T and N/2		Replaced by Micrologic 2		
35970	Circuit breaker NS100 SX STR22SE 100A 3P	LV429795	3P3D Micrologic 2.2 100 A NSX100N; Compact circuit breaker		
35971	Circuit breaker NS100 SX STR22SE 40A 3P	LV429797	3P3D Micrologic 2.2 40 A NSX100N; Compact circuit breaker		
35975	Circuit breaker NS100 SX STR22SE 100A 4P	LV429805	4P4D Micrologic 2.2 100 A NSX100N; Compact circuit breaker		
35976	Circuit breaker NS100 SX STR22SE 40A 4P	LV429807	4P4D Micrologic 2.2 40 A NSX100N; Compact circuit breaker		
35980	Circuit breaker NS160 SX STR22SE 160A 3P	LV430775	3P3D Micrologic 2.2 160 A NSX160N; Compact circuit breaker		
35981	Circuit breaker NS160 SX STR22SE 100A 3P	LV430776	3P3D Micrologic 2.2 100 A NSX160N; Compact circuit breaker		
35982	Circuit breaker NS160 SX STR22SE 40A 3P	LV430778	3P3D Micrologic 2.2 40 A NSX160N; Compact circuit breaker		
35985	Circuit breaker NS160 SX STR22SE 160A 4P	LV430785	4P4D Micrologic 2.2 160 A NSX160N; Compact circuit breaker		
35986	Circuit breaker NS160 SX STR22SE 100A 4P	LV430786	4P4D Micrologic 2.2 100 A NSX160N; Compact circuit breaker		
35987	Circuit breaker NS160 SX STR22SE 40A 4P	LV430788	4P4D Micrologic 2.2 40 A NSX160N; Compact circuit breaker		
35990	Circuit breaker NS250 SX STR22SE 250A 3P	LV431870	3P3D Micrologic 2.2 250 A NSX250N; Compact circuit breaker		
35991	Circuit breaker NS250 SX STR22SE 100A 3P	LV431872	3P3D Micrologic 2.2 100 A NSX250N; Compact circuit breaker		
35992	Circuit breaker NS250 SX STR22SE 40A 3P	LV431873	3P3D Micrologic 2.2 40 A NSX250N; Compact circuit breaker		
35995	Circuit breaker NS250 SX STR22SE 250A 4P	LV431875	4P4D Micrologic 2.2 250 A NSX250N; Compact circuit breaker		
35996	Circuit breaker NS250 SX STR22SE 100A 4P	LV431877	4P4D Micrologic 2.2 100 A NSX250N; Compact circuit breaker		
35997	Circuit breaker NS250 SX STR22SE 40A 4P	LV431878	4P4D Micrologic 2.2 40 A NSX250N; Compact circuit breaker		
36950	CT ground fault protection 150 A for NS400 to 630		Replaced by Micrologic	No	
36951	CT ground fault protection 250 A for NS400 to 630		Replaced by Micrologic	No	
36952	CT ground fault protection 400 A for NS400 to 630		Replaced by Micrologic	No	

Notes

Schneider Electric Industries SAS

35, rue Joseph Monier
CS 30323
F- 92506 Rueil Malmaison Cedex

RCS Nanterre 954 503 439
Capital social 896 313 776 €
www.schneider-electric.com

As standards, specifications and designs change from time to time, please ask for confirmation of the information given in this publication.



This document has been printed on ecological paper.

Design: Schneider Electric
Photos: Schneider Electric
Printed: